

# COLD ROOMS & REFRIGERATED CABINETS PROFILES



## CATALOGUE / KATALOG / КАТАЛОГ

FRIGOMONT a.s., Borek 40, 380 01 Dačice, Czech Republic

Tel.: (+420) 384 420 415 GSM: (+420) 724 022 030

Fax: (+420) 384 420 042 GSM: (+420) 603 818 352

E-mail: [frigomont@frigomont.cz](mailto:frigomont@frigomont.cz)

IČ: 26032732, DIČ: CZ26032732

Bankovní kontakt: GE Money Bank a.s.

Číslo účtu: 155333416/0600

IBAN: CZ74 0600 0000 0001 5533 3416

[www.frigomont.cz](http://www.frigomont.cz)

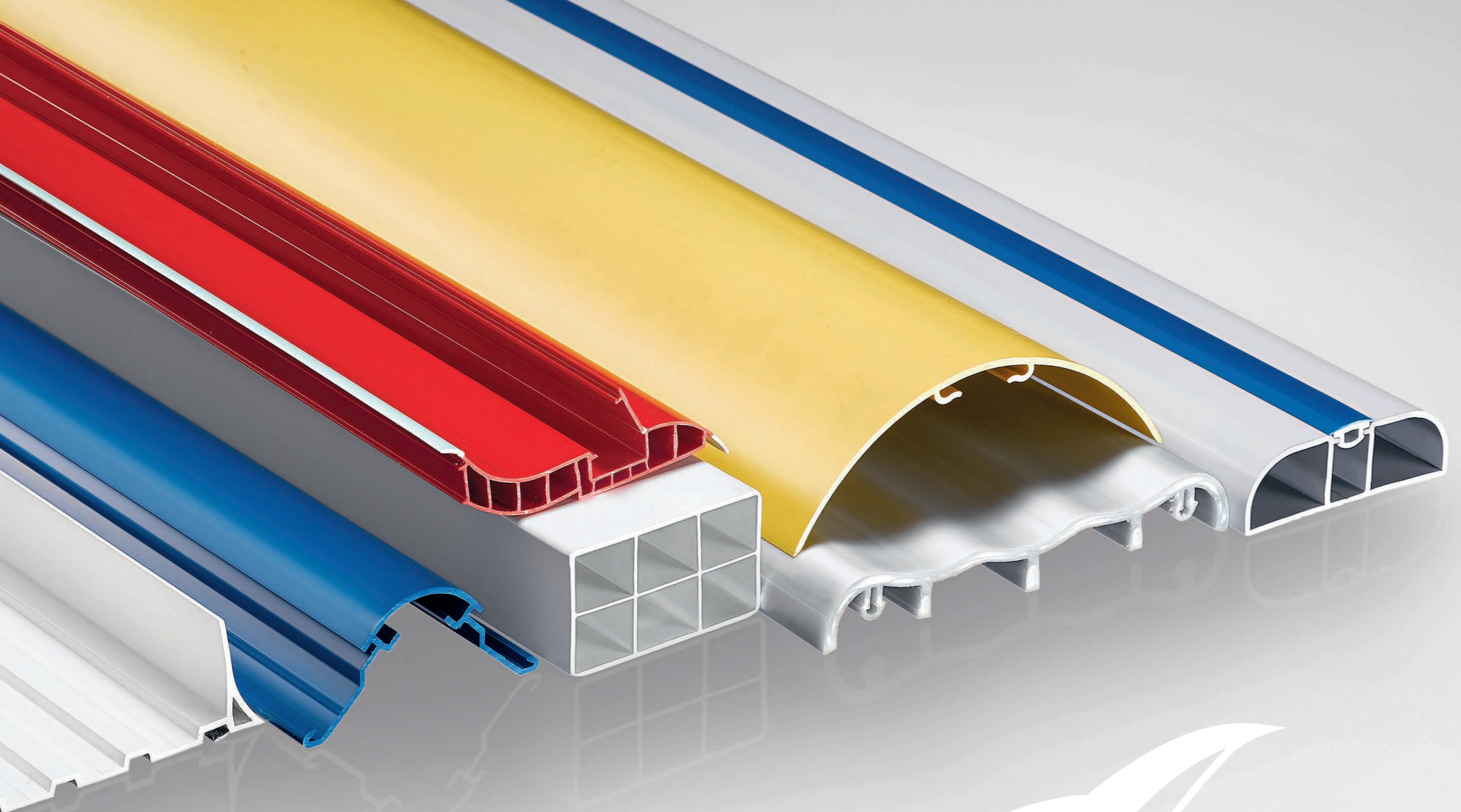

# COLD ROOMS AND REFRIGERATED CABINETS PROFILES

## CONTENTS

01	PVC Panels	10
02	Hermetic System	12
03	Standard System	16
04	Speed System	20
05	Modular System	24
06	Channels	28
07	Pillar System	32
08	Kerb	36
09	Antishock System	40
10	Door Frame	42
11	Door Leaf	48
12	Accessories for panels	54
13	Trims	58
14	T Suspension	60
15	Rack Protection	62
16	Guard Rail	64
17	Bumper 30	74
18	Bumper 50	76
19	Bumper 80	78
20	Bend 80	80
21	Bumper Superflex 80	82
22	Bumper Spongegum	84
23	Bumper Modular	86
24	Wall Protection	88
25	Bumper 150	92
26	Bumper Floor	94
27	Wheel System	96
28	Sliding System	100
29	PVC Profiles	104



## FRIGOMONT a.s.

**The company FRIGOMONT a.s. is** one of the leading companies with a focus on construction and design engineering of investment units. Fundamentals of the company were founded in 1994, when the current management started business career in the service field - assembly and sale of cold, freezing and air-conditioning technology trade organizations, food productions and public catering of citizens.

The company focuses on three main lines, which are closely linked:

- general supplies of industrial and food facilities
- supplies and assembly of cold storage and freezing technology
- production of doors, tinsmith and locksmith elements

They are applied in design and construction of industrial plants, such as:

- Large and small chillers and freezers
- Industrial and storage sheds
- Supermarkets, car shows, sport halls
- Reconstruction and insulation of existing buildings
- Installation of freezer and refrigerator technology into existing operations

The underlying assumption to obtain new contracts and expanding the operation of the market has become a good name, based on high expertise, guaranteed quality and provided guarantees.

**The main principles of our company is and always will be:  
QUALITY, TERMS AND SAFETY DURING BUILDINGS**

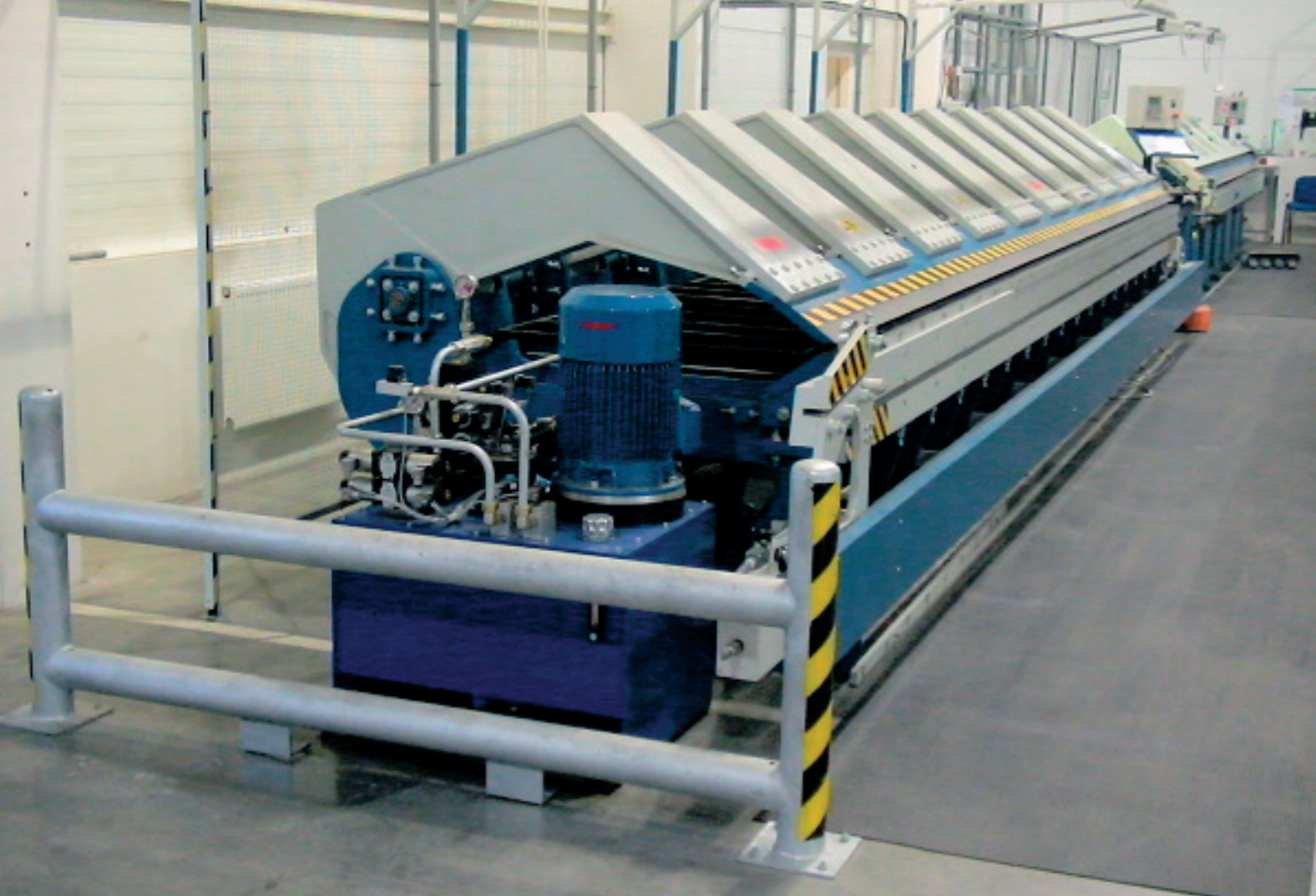

# MANUFACTURING PROCESS IL PROCESSO PRODUTTIVO



1 PROJECT PLAN  
STUDIO PROGETTO



2 MOULD MANUFACTURING  
PRODUZIONE STAMPO



3 MOULD REALIZED  
STAMPO FINITO

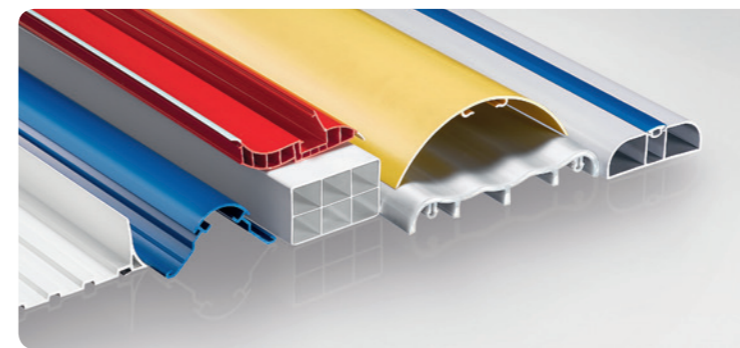

5 PRODUCTS RANGE  
GAMMA PRODOTTI

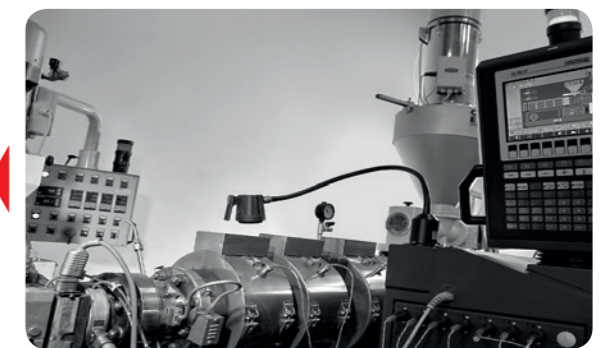

4 PROFILES MANUFACTURING  
PRODUZIONE PROFILI



EX-

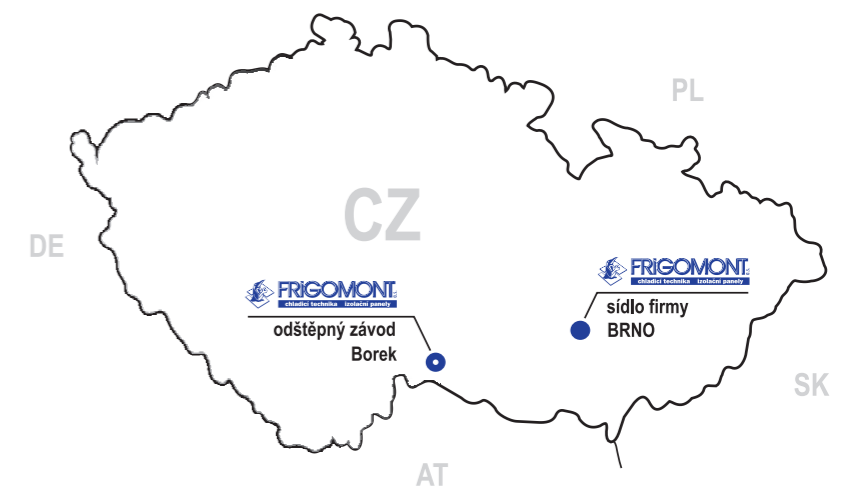

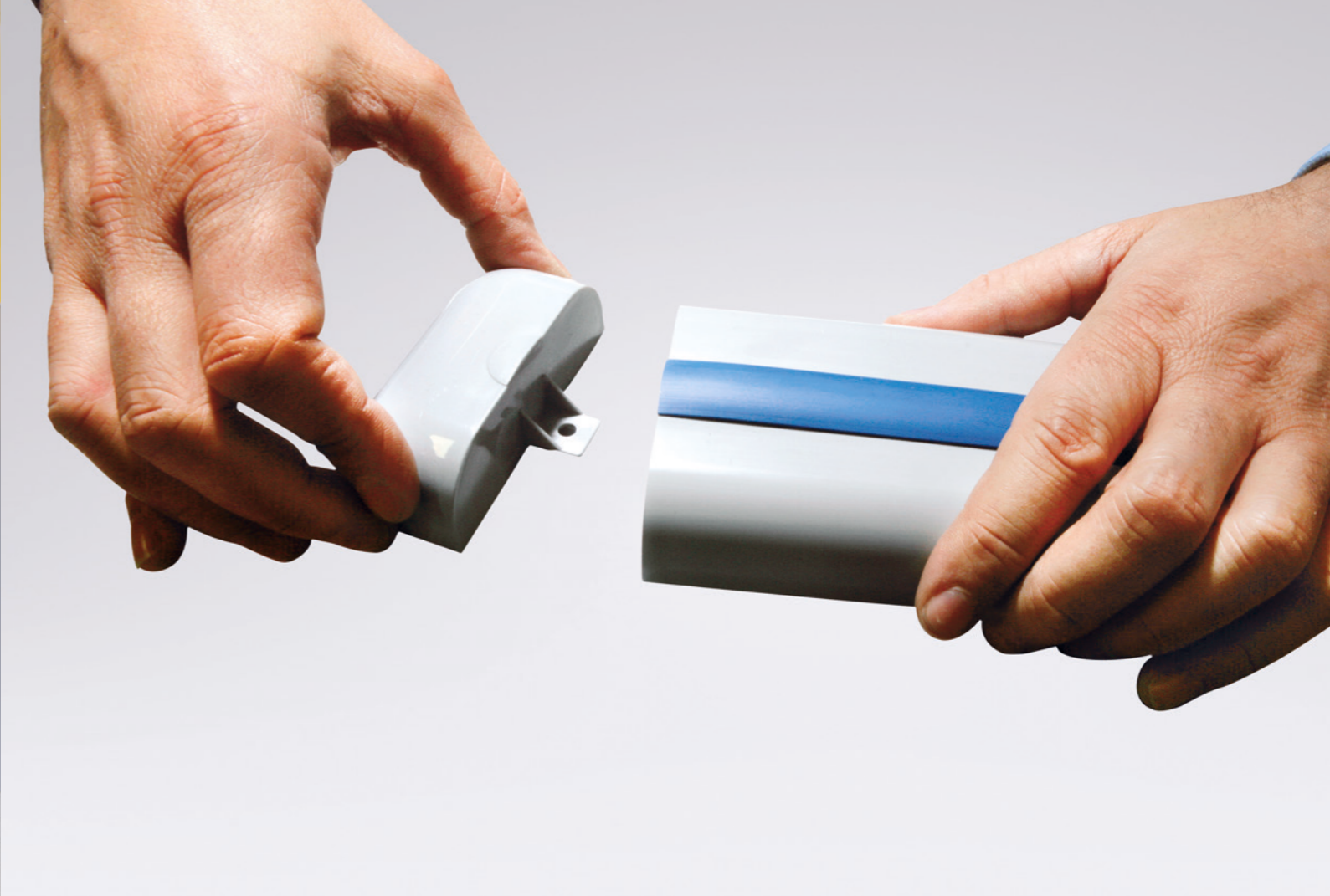

## DETAILED SOLUTIONS SOLUZIONI MIRATE

### SOLUTIONS FOR DIFFERENT FIELDS

ABS	acrylonitrile butadiene styrene
PC	polycarbonate
PE	polyethylene
TPE	thermoplastic rubber
SEBS	thermoplastic rubber
PMMA	polymethyl methacrylate
PP	polypropylene
PS	polystyrene
PVC	polyvinyl chloride
PVCE	expanded foam polyvinyl chloride
PUR	polyurethane

### SOLUZIONI PER OGNI SETTORE

ABS	acrilonitrile-butadiene-stirolo
PC	policarbonato
PE	polietilene
TPE	gomma termoplastica
SEBS	gomma termoplastica
PMMA	polimetilmetacrilato
PP	polipropilene
PS	polistirolo-polistirene
PVC	policloruro di vinile
PVCE	policloruro di vinile espanso
PUR	poliuretano

# 01 PVC PANELS

PVC sheets to renovate fastly and cheaply the walls of cold rooms and cold store.

Lastre in PVC per il rinnovo rapido ed economico delle pareti nelle celle e nei magazzini frigoriferi.

Plaques en PVC pour renover rapidement et a bas prix les murs de chambres froides et de depots frigorifiques.



**PF 300**

Foamed inside



Length **4.000 mm**  
Packing **to be defined**  
Colour **E**



**PR 300**

Length **4.000 mm**  
Packing **to be defined**  
Colour **E**



**PJ**

To install with PR 300 and PF 300

Length **4.000 mm**  
Packing **to be defined**  
Colour **E**

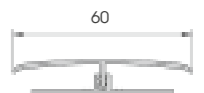

**PA**

To install with PR 300 and PF 300

Length **4.000 mm**  
Packing **to be defined**  
Colour **E**



**PT**

To install with PR 300 and PF 300

Length **4.000 mm**  
Packing **to be defined**  
Colour **E**

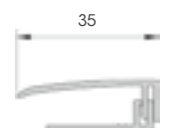

# 02

# HERMETIC SYSTEM

New sanitary system, excellent water and dirty resistant, provided with a new plinth with a large flap to make the installation easier and bi material caps to grant hermetic closing. To be used with standard hygienic corners.

Nuovo sistema profili sanitari con un battiscopa dotato di grande sportello per facilitare l'installazione. Completo di tappi in bimatereale per una chiusura ermetica. Ottima tenuta dell'acqua e dello sporco. Utilizzabile con angoli sanitari standard.

Nouveau système sanitaire, résistant à l'eau et à l'impureté, doté d'une plinthe avec une grande porte pour faciliter l'installation et accessoires injectés en bi matériel pour une fermeture hermétique. À utiliser avec les congés d'angle standards.

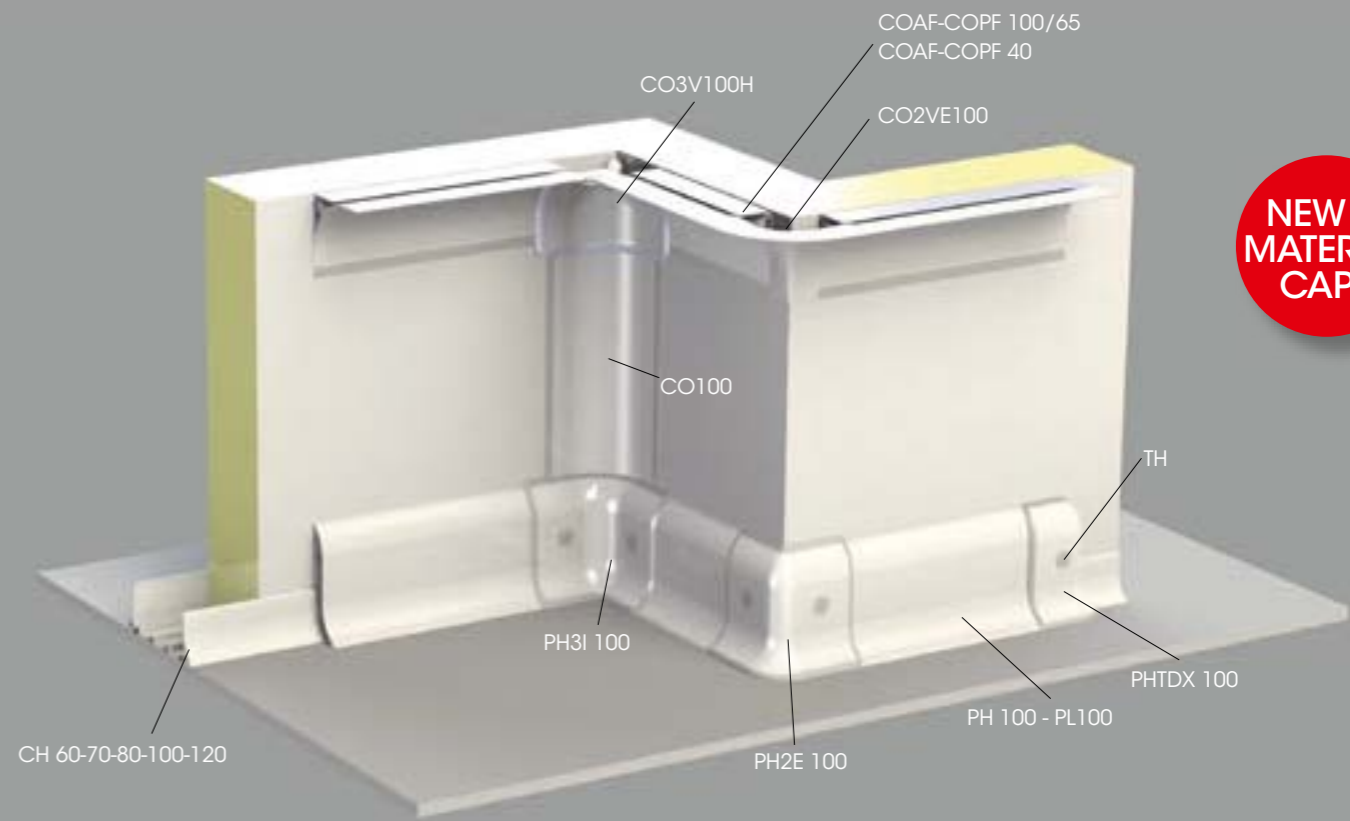

**NEW BI MATERIAL CAPS**

NEW CAPS ALSO TO BE USED WITH PL 100  
NOUVEAUX EMBOUTS À UTILISER AUSSI AVEC PL 100  
NUOVI TAPPI UTILIZZABILI ANCHE CON PL 100



	<b>CS 65</b>	Length Packing Colour	<b>4.000 mm</b> <b>25 pz / box</b> E F	
	<b>CO 65</b>	Length Packing Colour	<b>4.000 mm</b> <b>25 pz / box</b> B E F	
	<b>CO 100</b>	Length Packing Colour	<b>4.000 mm</b> <b>25 pz / box</b> E F	
	<b>CSP with holes CSA</b>	Material Length Packing	<b>CSP plastic</b> <b>CSA aluminium</b> <b>4000 mm</b> <b>CSP</b> <b>25 pz / box</b> <b>CSA</b> <b>25 pz / bundle</b>	
	<b>COPF 100-65 with holes COAF 100-65</b>	Material Length Packing	<b>COPF plastic</b> <b>COAF aluminium</b> <b>4.000 mm</b> <b>COPF 100-65</b> <b>25 pz / box</b> <b>COAF 100-65</b> <b>25 pz / bundle</b>	
	<b>COPF 40 with holes COAF 40</b>	Material Length Packing	<b>COPF plastic</b> <b>COAF aluminium</b> <b>4.000 mm</b> <b>COPF 40</b> <b>25 pz / box</b> <b>COAF 40</b> <b>25 pz / bundle</b>	
	<b>CP 100</b>	Length Packing Colour	<b>4.000 mm</b> <b>10 pz / box</b> B C E F	
	<b>CPF 100</b>	Material Length Packing	<b>plastic</b> <b>4.000 mm</b> <b>10 pz / bag</b>	
	<b>CPT 100</b>	Packing Colour	<b>to be defined</b> B E F	

	<b>PH 100</b>		Length Packing Colour	<b>4.000 mm</b> <b>13 pz / box</b> E F	
	<b>CO3V 65</b>		Packing Colour	<b>100 pz / box</b> B E F	
	<b>CO3V 100 H</b>		To install with TH Packing Colour	<b>50 pz / box</b> E F	
	<b>CO2VE 65 CO2VE 100</b>		Packing Colour	<b>100 pz / box</b> E F	
	<b>COT 100</b>		Packing Colour	<b>100 pz / box</b> E F	
	<b>PH2I 100</b>		To install with TH Packing Colour	<b>50 pz / box</b> E F	
	<b>PH3I 100</b>		To install with TH Packing Colour	<b>50 pz / box</b> E F	
	<b>PH2E 100</b>		To install with TH Packing Colour	<b>50 pz / box</b> E F	
	<b>PHTDX 100 PHTSX 100</b>		To install with TH Packing Colour	<b>50 pz / box</b> E F	



# 03

## STANDARD SYSTEM











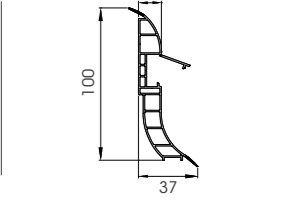

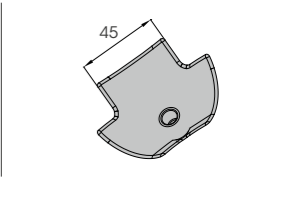

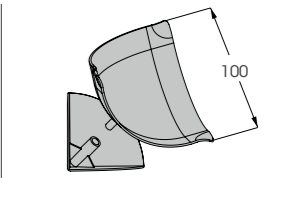

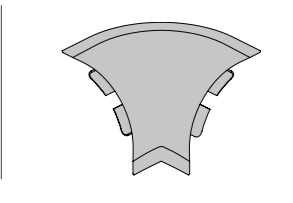
Basic hygienic corner with aluminium or pvc guide, with soft fins to fix it to the wall to assure hygiene. It can be used with plinth.

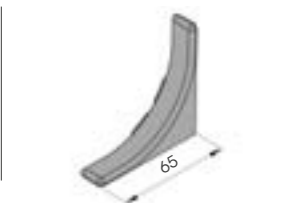
Angolo sanitario classico con supporto in alluminio o pvc. Provisto di alette morbide per assicurare il fissaggio alle pareti ed evitare il passaggio dello sporco. Perfetta combinazione con il battiscopa a pavimento.

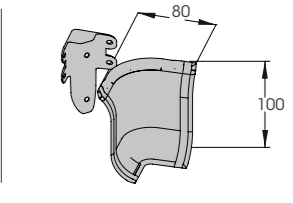
Système d'angle standard hygiénique avec un support en aluminium ou en pvc. Dispose d'ailettes souples assurant une adhésion aux murs afin d'éviter le passage de la poussière. Peut-être utilisé avec des plinthes.

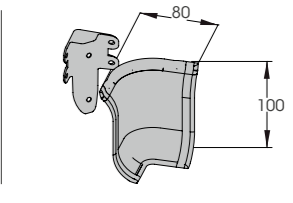

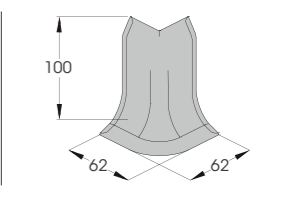
	<b>CS 45</b>	Length Packing Colour	<b>4.000 mm</b> <b>50 pz / box</b> E F	
	<b>CO 65</b>	Length Packing Colour	<b>4.000 mm</b> <b>25 pz / box</b> B E F	
	<b>CO 100</b>	Length Packing Colour	<b>4.000 mm</b> <b>25 pz / box</b> E F	
	<b>CSP 45</b>	Length Packing	<b>4.000 mm</b> <b>50 pz / box</b>	
	<b>COPF 100-65 with holes</b> <b>COAF 100-65</b>	Material Length Packing	<b>COPF plastic</b> <b>COAF aluminium</b> <b>4.000 mm</b> <b>COPF 100-65</b> <b>25 pz / box</b> <b>COAF 100-65</b> <b>25 pz / bundle</b>	
	<b>COPF 40 with holes</b> <b>COAF 40</b>	Material Length Packing	<b>COPF plastic</b> <b>COAF aluminium</b> <b>4.000 mm</b> <b>COPF 40</b> <b>25 pz / box</b> <b>COAF 40</b> <b>25 pz / bundle</b>	
	<b>CP 100</b>	Length Packing Colour	<b>4.000 mm</b> <b>10 pz / box</b> B C E F	
	<b>CPF 100</b>	Length Packing	<b>4.000 mm</b> <b>10 pz / bag</b>	
	<b>CPT 100</b>	Packing Colour	<b>to be defined</b> B E F	

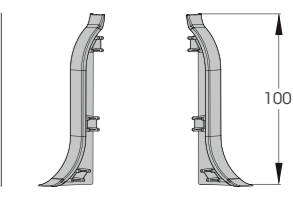
	<b>PL 100</b>	Length Packing Colour	<b>4.000 mm</b> <b>12 pz / box</b> E F	
	<b>CO3V 45</b> To install with TM5	Packing Colour	<b>100 pz / box</b> E	
	<b>CO3V 65</b> <b>CO3V 100</b>	Packing Colour	<b>100 pz / box</b> E F	
	<b>CO2VE 65</b> <b>CO2VE 100</b>	Packing Colour	<b>100 pz / box</b> E F	
	<b>COT 100</b>	Packing Colour	<b>100 pz / box</b> E F	
	<b>PL2I 100</b>	Packing Colour	<b>50 pz / box</b> E F	
	<b>PL3I 100</b>	Packing Colour	<b>50 pz / box</b> E F	
	<b>PL2E 100</b>	Packing Colour	<b>50 pz / box</b> E F	
	<b>PLTDX 100</b> <b>PLTSX 100</b>	Packing Colour	<b>100 pz / box</b> E F	

# 04

## SPEED SYSTEM

Hygienic corner system rapid and easy to install, available with fixing buttons on the ending caps which eliminate the need for the wall drilling.

Linea d'angolo sanitario rapida e facile da installare che elimina la foratura alle pareti sostituita da bottoni di supporto ai terminali.

Congé d'angle sanitaire facile à l'installation qui permet d'éviter la perforation de murs grâce à des embouts à pression insérés dans les espaces préforés.

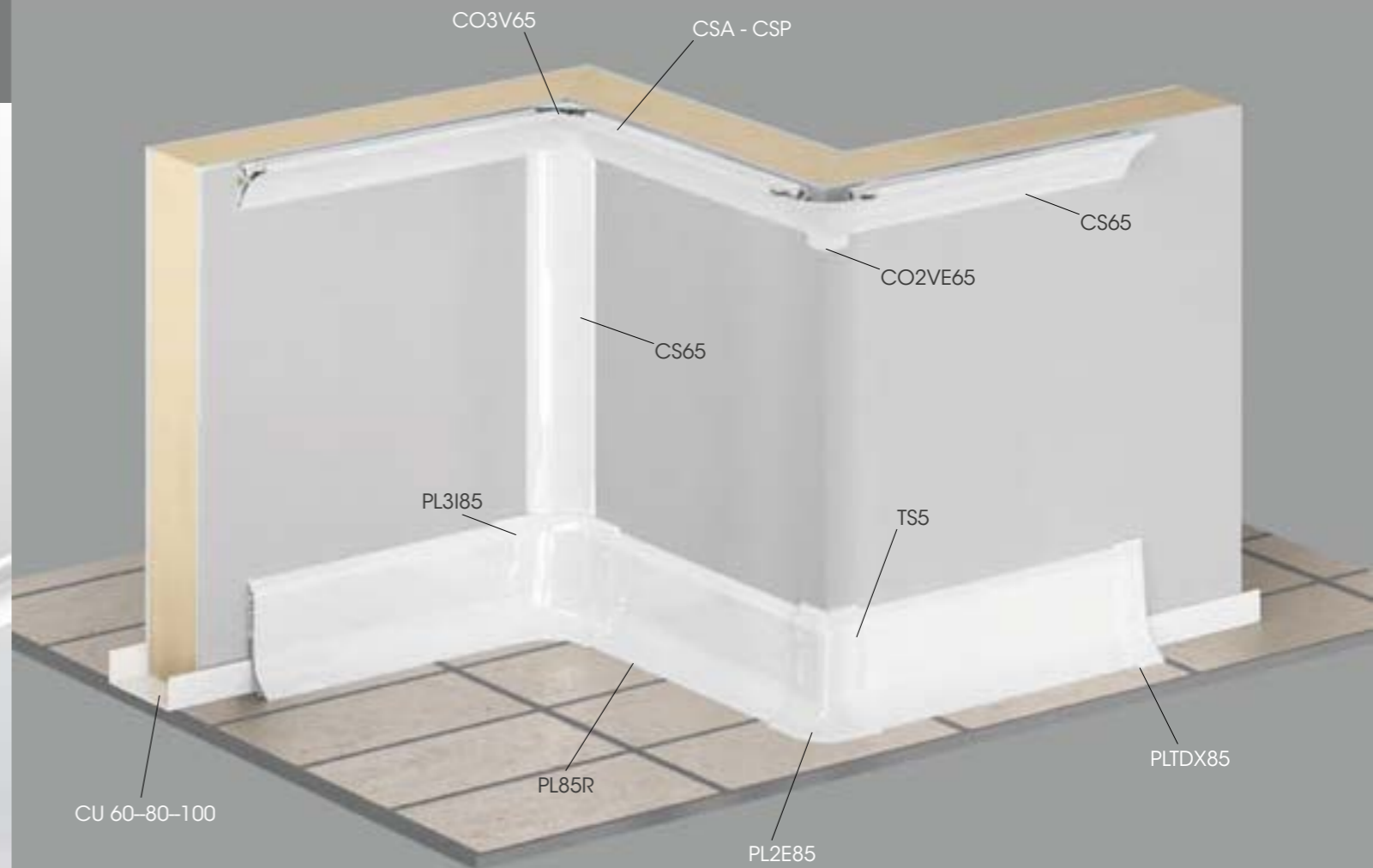



**CS 65**

Length **4.000 mm**  
Packing **25 pz / box**  
Colour **E F**

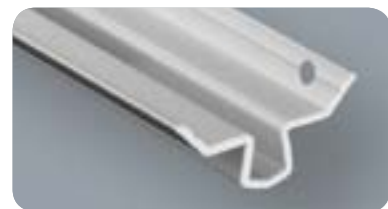
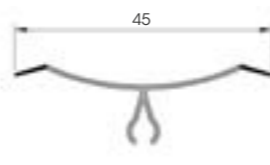

**CSP with holes**  
**CSA**

Material **CSP plastic**  
**CSA aluminium**  
Length **4.000 mm**  
Packing **CSP**  
**25 pz / box**  
**CSA**  
**25 pz / bundle**

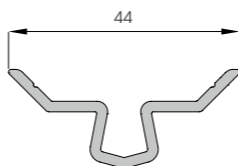

**CP 100**

Length **4.000 mm**  
Packing **10 pz / box**  
Colour **B C E F**

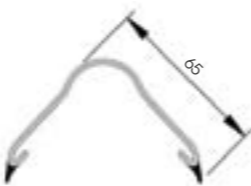

**CPF 100**

Material **plastic**  
Length **4.000 mm**  
Packing **10 pz / bag**



**CPT 100**

Packing **to be defined**  
Colour **B E F**

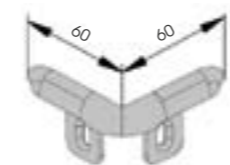

**PL 85 R**

Length **4.000 mm**  
Packing **14 pz / box**  
Colour **E F**

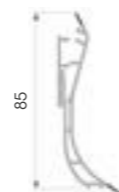

**PL2I 85 with holes**  
**PL2I 85 NH without holes**

To install with TS5

Packing **50 pz / box**  
Colour **E F**

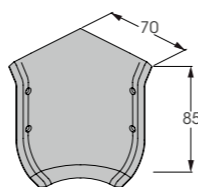

**PL3I 85 with holes**  
**PL3I 85 NH without holes**

To install with TS5

Packing **50 pz / box**  
Colour **E F**

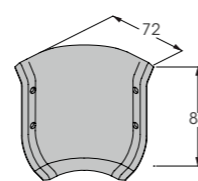

**PL2E 85 with holes**  
**PL2E 85 NH without holes**

To install with TS5

Packing **50 pz / box**  
Colour **E F**

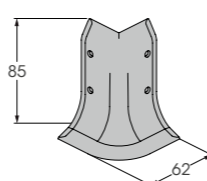

**PLTDX 85 with holes**  
**PLTSX 85 with holes**  
**PLTDX 85 NH without holes**  
**PLTSX 85 NH without holes**

To install with TS5

Packing **100 pz / box**  
Colour **E F**

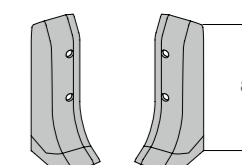

# 05

# MODULAR SYSTEM

Complete system with the possibility to change the size of profiles and internal caps which suit all the solutions. Warranty and easy way to fix it. Hidden screws.

Sistema completo con possibilità di allungamento modulare dei profili e raccordi interni che si adattano a tutte le combinazioni. Garanzia e facilità di fissaggio. Viti a scomparsa.

Système modulable complet avec la possibilité de modifier la taille des profilés et des raccords internes, qui s'adapte alors à toutes les solutions. Solidité garantie et facile à fixer. Vis dissimulées.

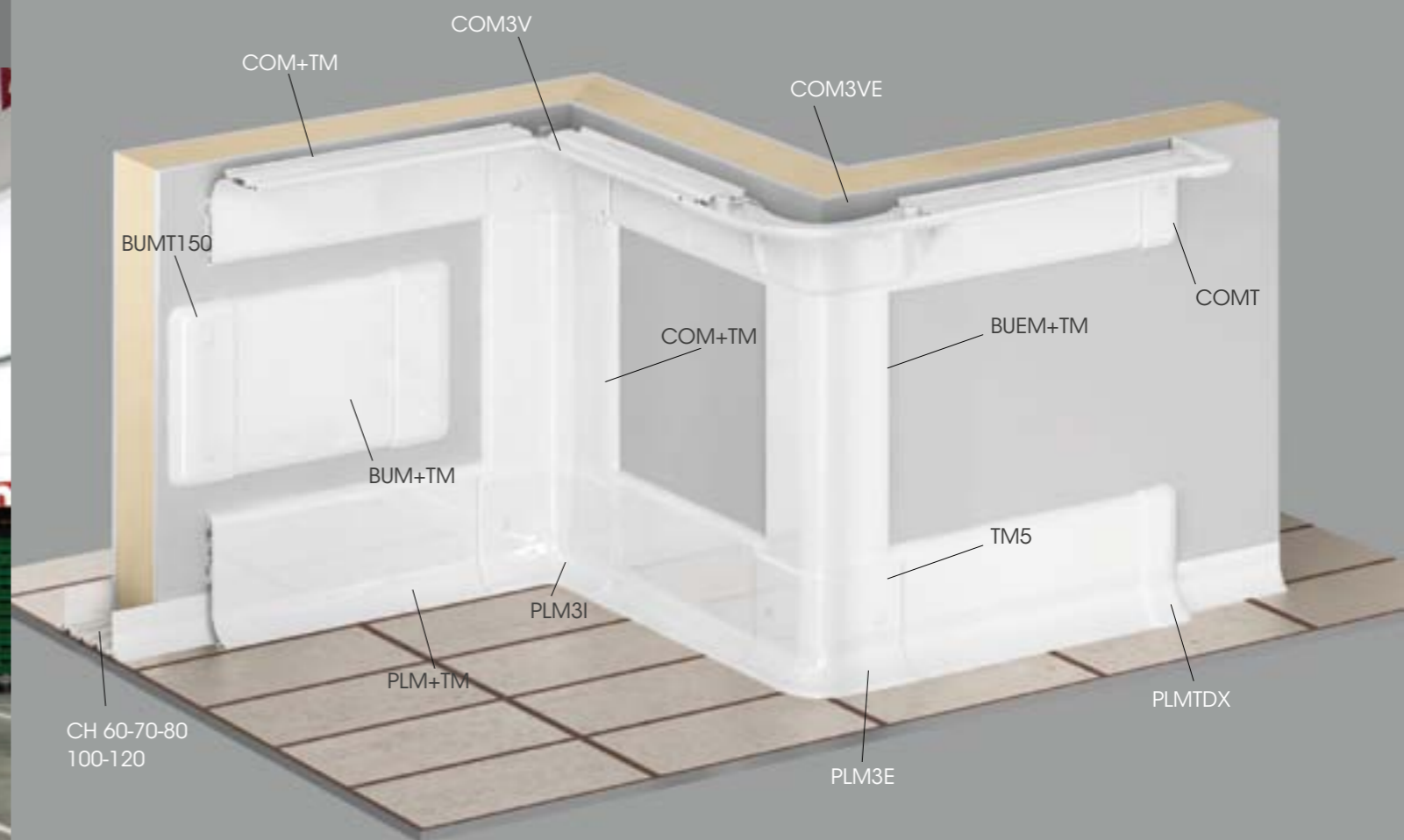

	<b>TM</b>	Length Packing Colour B E	4.000 mm 40 pz / box	
	<b>EXM</b>	Length Packing Colour B E	4.000 mm 20 pz / box	
	<b>PLM</b>	Length Packing Colour B E	4.000 mm 10 pz / box	
	<b>COM</b>	Length Packing Colour B E	4.000 mm 10 pz / box	
	<b>BUEM</b>	Length Packing Colour B E	4.000 mm 10 pz / box	
	<b>BUM</b>	Length Packing Colour A B C E G H	4.000 mm 8 pz / box / scatola	
	<b>PLM3I</b> To install with TM5	Packing Colour B E	50 pz / box	
	<b>PLM3E</b> To install with TM5	Packing Colour B E	50 pz / box	
	<b>PLMT DX/SX</b> To install with TM5	Packing Colour B E	100 pz / box	

	<b>COM3 V</b> To install with TM5	Packing Colour B E	50 pz / box	
	<b>COM3 VE</b> To install with TM5	Packing Colour B E	25 pz / box	
	<b>COMT</b> To install with TM5	Packing Colour B E	50 pz / box	
	<b>BUMT 150</b> To install with TM5	Packing Colour B E	50 pz / box	
	<b>BUMT 250</b> To install with TS7	Packing Colour B E	25 pz / box	
	<b>PLN3I 100</b> To install with TM5	Packing Colour B E	50 pz / box	
	<b>PLN2E 100</b> To install with TM5	Packing Colour B E	50 pz / box	

06

OUR CHANNELS  
FIT FOR ALL OUR  
PLINTHS

# CHANNELS

Different sizes available with rounded sides and soft fins for a good fit to the floor. Cheap models available, see CU.

Ampia scelta tra canale grecate con bordi arrotondati e alette morbide per assicurare maggiore tenuta. Disponibili anche in versione più economica, vedi CU.

Plusieurs dimensions sont disponibles, nervurées avec des bords arrondis et des ailettes souples pour permettre une meilleure adhésion au sol. Différents modèles économiques disponibles, voir CU.

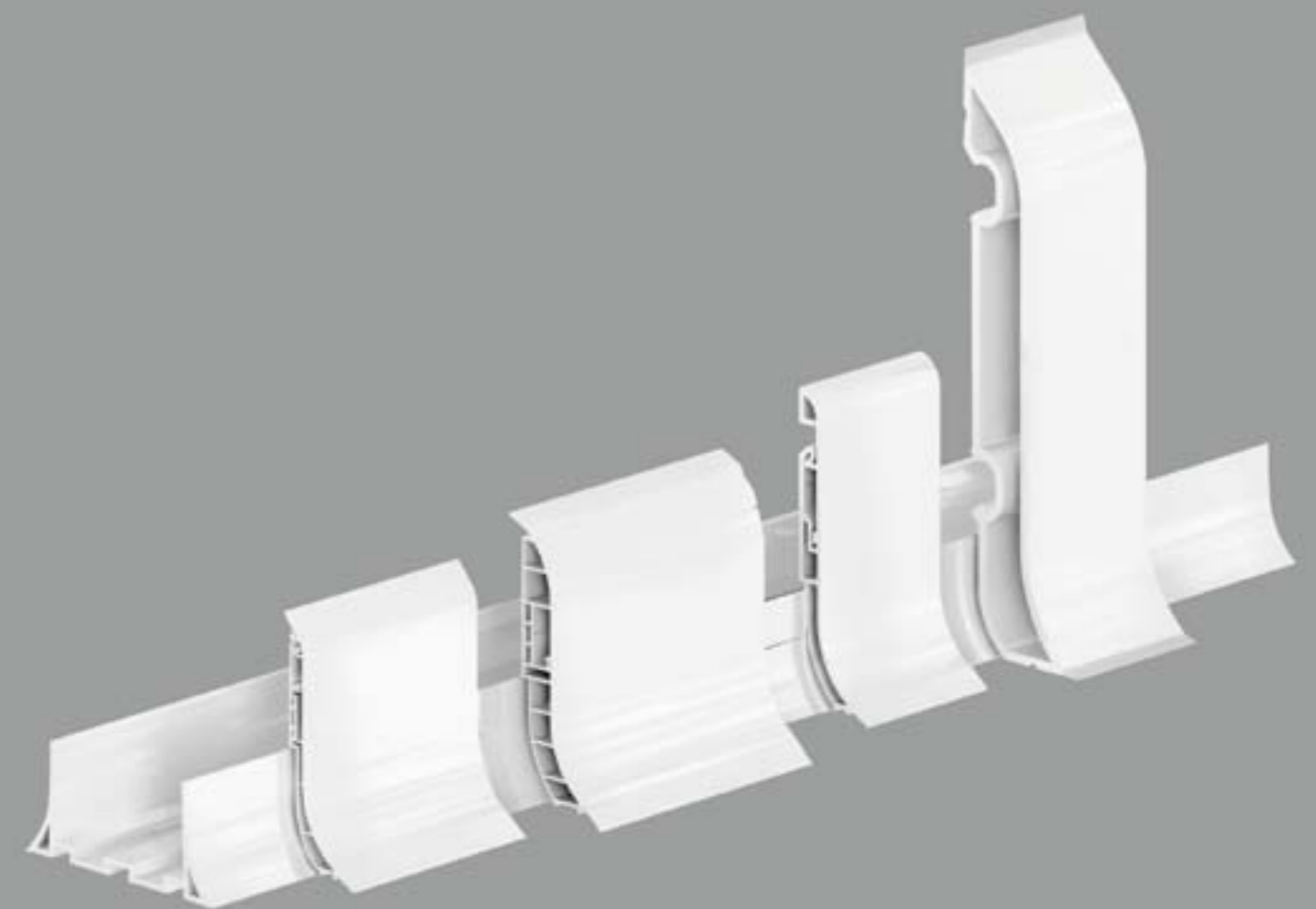

# Channels



**CH 60**

Length **4.000 mm**  
Packing **2 pz / bundle**  
Colour **E F**

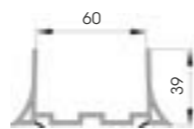

**CH 70**

Length **4.000 mm**  
Packing **2 pz / bundle**  
Colour **E F**

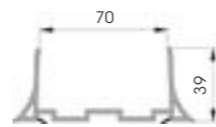

**CH 80**

Length **4.000 mm**  
Packing **2 pz / bundle**  
Colour **E F**

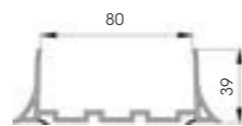

**CH 100**

Length **4.000 mm**  
Packing **2 pz / bundle**  
Colour **E F**

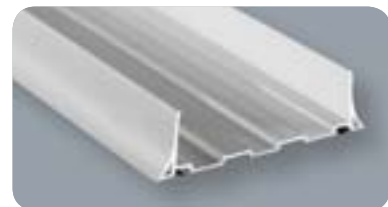
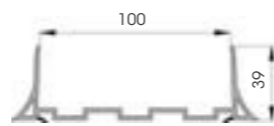

**CH 120**

Length **4.000 mm**  
Packing **2 pz / bundle**  
Colour **E F**

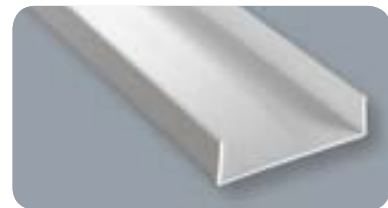
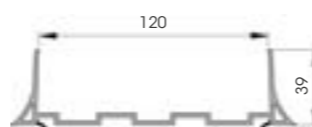

**CU 60**

Length **4.000 mm**  
Packing **2 pz / bundle**  
Colour **E F**

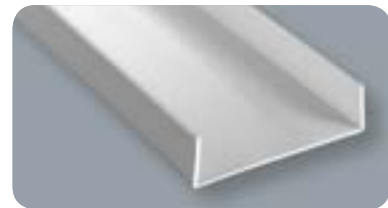
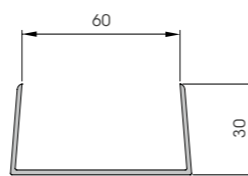

**CU 80**

Length **4.000 m**  
Packing **2 pz / bundle**  
Colour **E F**

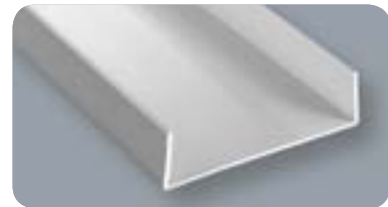
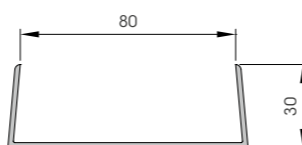

**CU 100**

Length **4.000 mm**  
Packing **2 pz / bundle**  
Colour **E F**

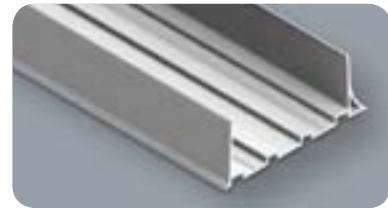
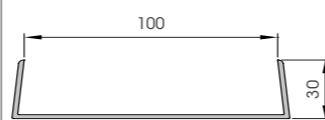

**CL 80**

Length **4.000 mm**  
Packing **8 pz / box**  
Colour **E F**

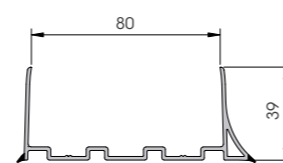

# Channels

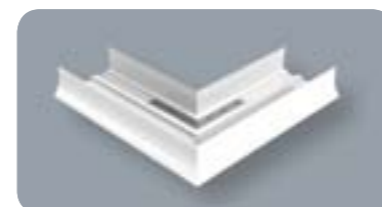

**CHL**

Available in 60-70  
80-100-120 sizes

Packing **to be defined**  
Colour **E F**

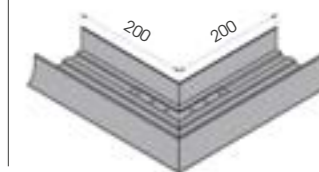

**CHT**

Available in 60-70  
80-100-120 sizes

Packing **to be defined**  
Colour **E F**

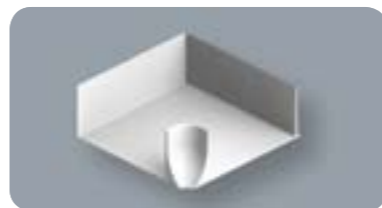
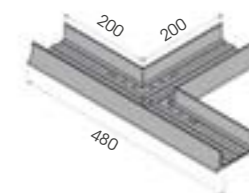

**CLA 80 R 13**

To install with  
CL 80 radius 13

Packing **24 pz / box**  
Colour **E F**

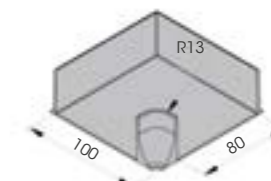

**CHA 60 R 15**

To install with  
CH 60 radius 15

Packing **24 pz / box**  
Colour **E F**

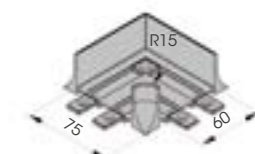



# 07

## PILLAR SYSTEM

Cheap and useful system studied for quick planning and installation of cold rooms. Perfect isolation, equipped with an internal rounded corner for easy cleaning.

Sistema economico e funzionale ideato per la rapida progettazione e gestione delle celle frigorifere. Ottimo isolamento, accessorio con angoli arrotondati all'interno per facilitare la pulizia.

Système pratique et économique étudié pour la réalisation et la gestion de chambres froides. Isolation parfaite, équipé d'angles arrondis à l'intérieur pour faciliter le nettoyage.

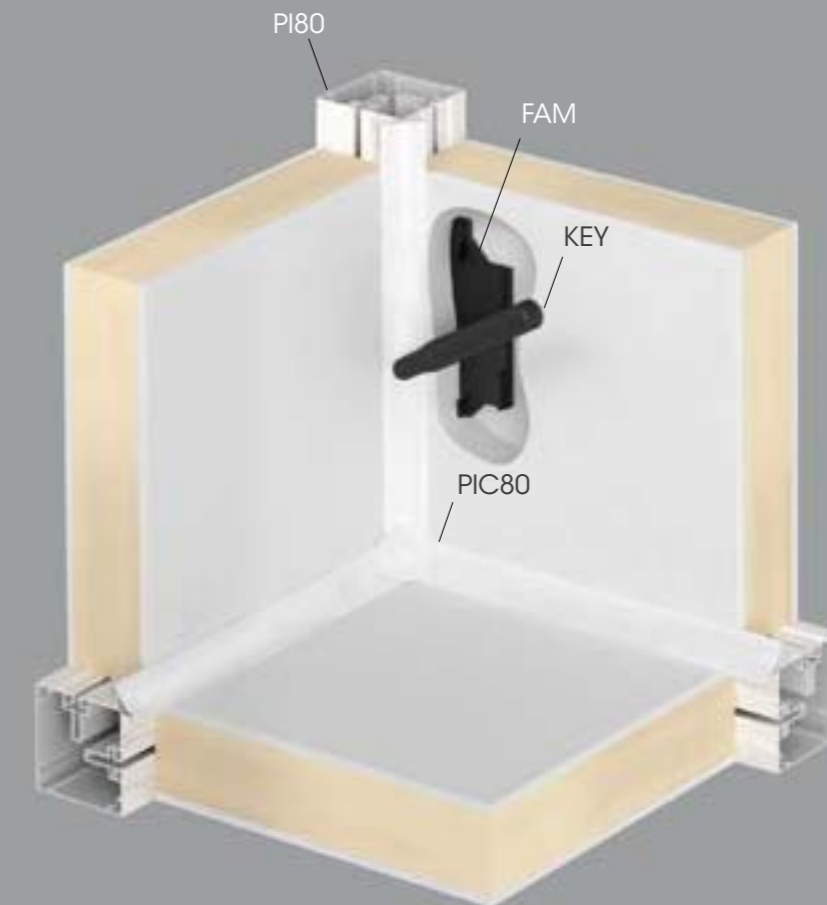



**PI 80**

Length **4.000 mm**  
Packing **unpacked on pallet**  
Colour **E**

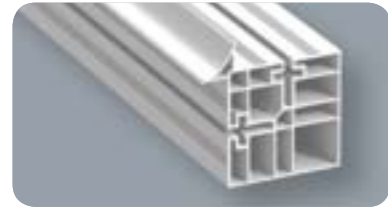
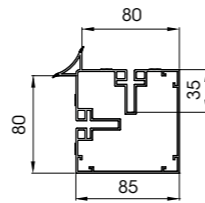

**PIT 80**

Length **4.000 mm**  
Packing **unpacked on pallet**  
Colour **E**

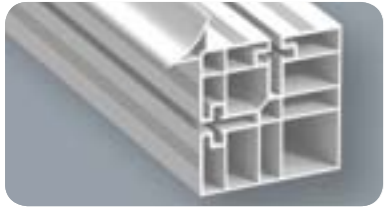
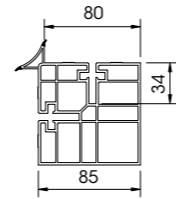

**PIT 120**

Length **4.000 mm**  
Packing **unpacked on pallet**  
Colour **E**

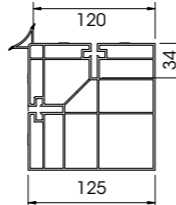

**GE**

Packing **25 pz / bundle**

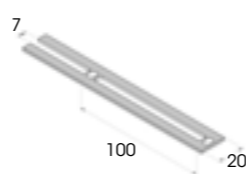

**FAM**

Packing **200 pz / box**  
Colour **D**

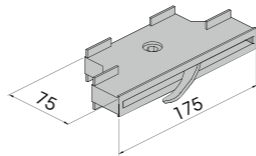

**FAF**

Packing **200 pz / box**  
Colour **D**

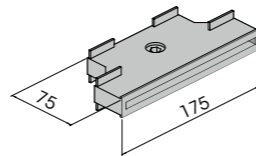

**KEY**

Packing **100 pz / box / scatola**  
Colour **D**

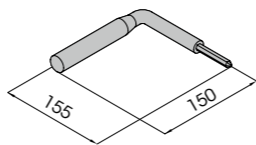

**PIC 80**

Packing **8 pz / box**  
Colour **E**

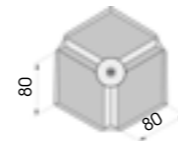

**PIC 120**

Packing **4 pz / box**  
Colour **E**

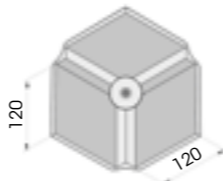

08

## KERB

To install with Channels CH and CU  
 Monta con canale CH e CU  
 À installer avec les U de sol CH et CU



A large size protection system,  
 ideal for walls and panels.  
 Easy to install and clean.  
 Fully equipped with corner  
 caps and buttons.

Sistema di protezione di grandi  
 dimensioni, ideale per muri e  
 pannelli. Facile da installare e pulire.  
 Completo di angolari e tappi.

Système de protection de grands  
 dimensions, idéal pour les murs et  
 les panneaux. Facile à installer et  
 à nettoyer. Complété de bouchons  
 d'angles et d'embouts.





**KS 200**

Length **4.000 mm**  
Packing **3 pz / box**  
Colour **B C E**

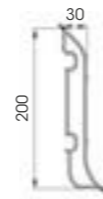

**KEPF 200**

To install with TB14

Packing **50 pz / box**  
Colour **K**



**KSJ 200**

To install with TB14

Packing **20 pz / box**  
Colour **B E**

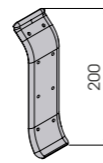

**KSI 200**

To install with TB14

Packing **20 pz / box**  
Colour **B E**

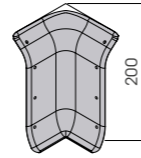

**KSE 200**

To install with TB14

Packing **20 pz / box**  
Colour **B E**

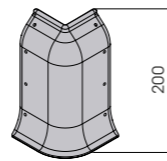

**KSTD/SX 200**

To install with TB14

Packing **20 pz / box**  
Colour **B E**

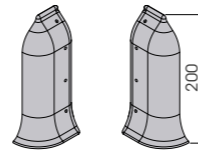

**CP 200**

Length **4.000 mm**  
Packing **2 pz / bag**  
Colour **B C E**



**CPF 200**

Length **4.000 mm**  
Packing **2 pz / bag**



**CPT 200**

Packing **to be defined**  
Colour **B E**

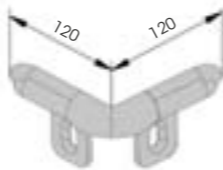

**KS 300**

Length **4.000 mm**  
Packing **to be defined**  
Colour **B C E**

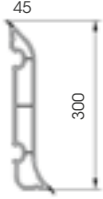

**KEPF 300**

To install with TB20

Packing **to be defined**  
Colour **K**

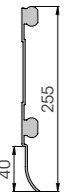

**KSJ 300**

To install with TB20

Packing **to be defined**  
Colour **B E**

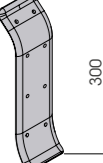

**KSI 300**

To install with TB20

Packing **to be defined**  
Colour **B E**

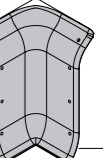

**KSE 300**

To install with TB20

Packing **to be defined**  
Colour **B E**

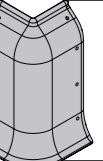

**KSTD/SX 300**

To install with TB20

Packing **to be defined**  
Colour **B E**

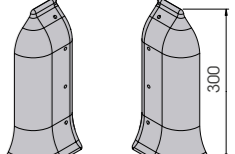

**FRIGOMONT<sup>®</sup>**  
**chladicí technika izolační panely**

# 09

# ANTISHOCK SYSTEM

New bumper and plinth system produced in soft material, could be used in cold rooms, refrigerated storages and garages. Thanks to material elasticity, it features good anti-shock property.

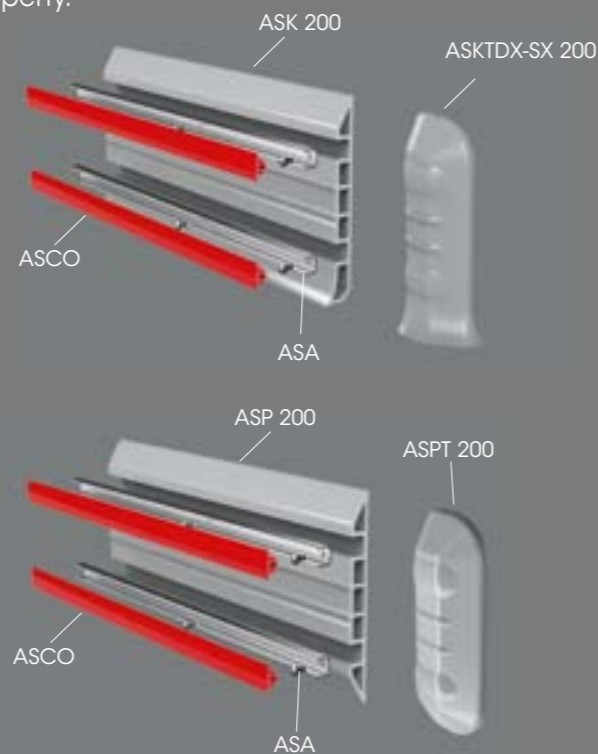

Nuova linea di paracolpi e battiscopa in materiale morbido per celle frigo, magazzini refrigerati, garage. Ottima proprietà anti-urto grazie all'elasticità del materiale utilizzato.

Nouvelle gamme de lisses de protection et plinthes en matière souple pour les chambres froides, depots et garages. Excellente propriété anti-choc grâce à l'élasticité du matériel utilisé.

## Antishock System

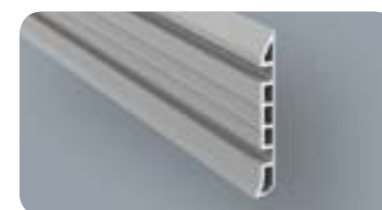

**ASK 200**



Length **4.000 mm**  
Packing **to be defined**  
Colour **B C**



**ASK2I200**



Packing **to be defined**  
Colour **B**

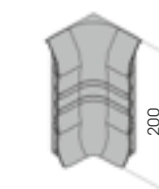

**ASK2E 200**



Packing **to be defined**  
Colour **B**



**ASKTDX-SX 200**



Packing **to be defined**  
Colour **B**

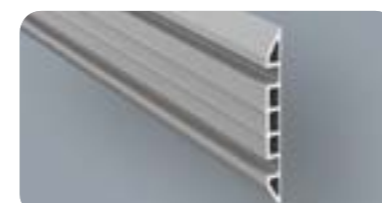
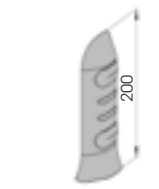

**ASP 200**



Length **4.000 mm**  
Packing **to be defined**  
Colour **B C**

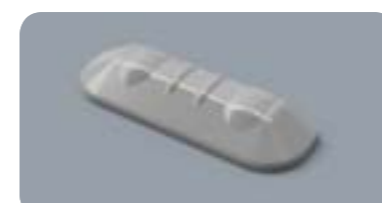

**ASPT 200**



Packing **to be defined**  
Colour **B**

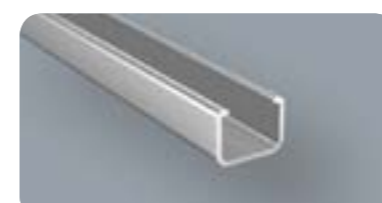
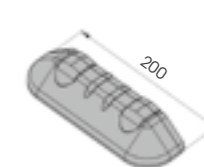

**ASA**

Material **aluminium**  
Length **4.000 mm**  
Packing **to be defined**

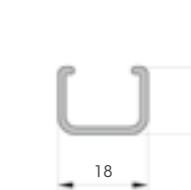

**ASCO**



Length **60 mt / reel**  
Packing **cardboard reel**  
Colour **A B C D E G**

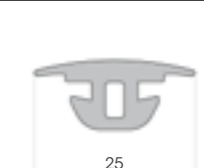

# 10 DOOR FRAME

Modular system which suits different sizes and thicknesses with the possibility to build corners welding or inserting fast connections. It's equipped with spaces for resistance and for additional supports to add during the assembly. It can be covered with plates.

Sistema modulare adeguabile a differenti spessori con possibilità di effettuare angoli a saldatura o con innesti rapidi. Provisto di passaggio per resistenza e di insenature per l'inserimento di rinforzi durante il montaggio degli accessori. Rivestibile con lamiera.

Système modulable qui s'adapte à différentes épaisseurs et dimensions, avec la possibilité de réaliser des angles à souder ou avec des connexions rapides. Equipé d'espaces pour le passage de résistances et de renforcements additionnels pour le montage des accessoires. Peut-être revêtu des tôles.

Door Frame

## BIS VERSION

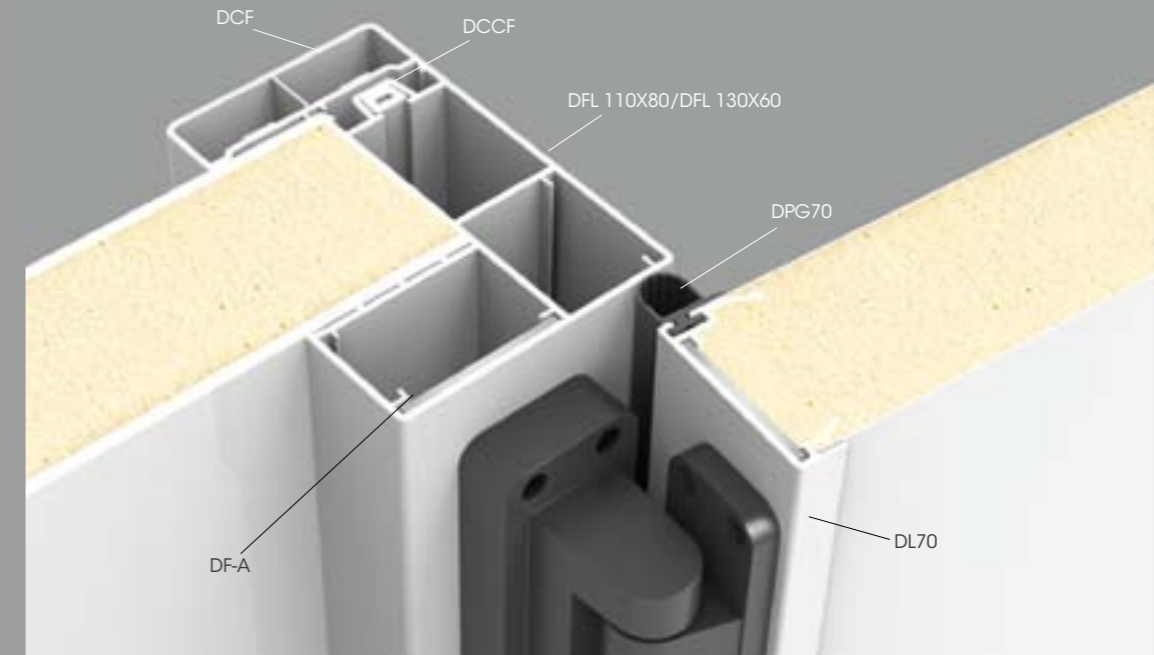

## TRIS VERSION

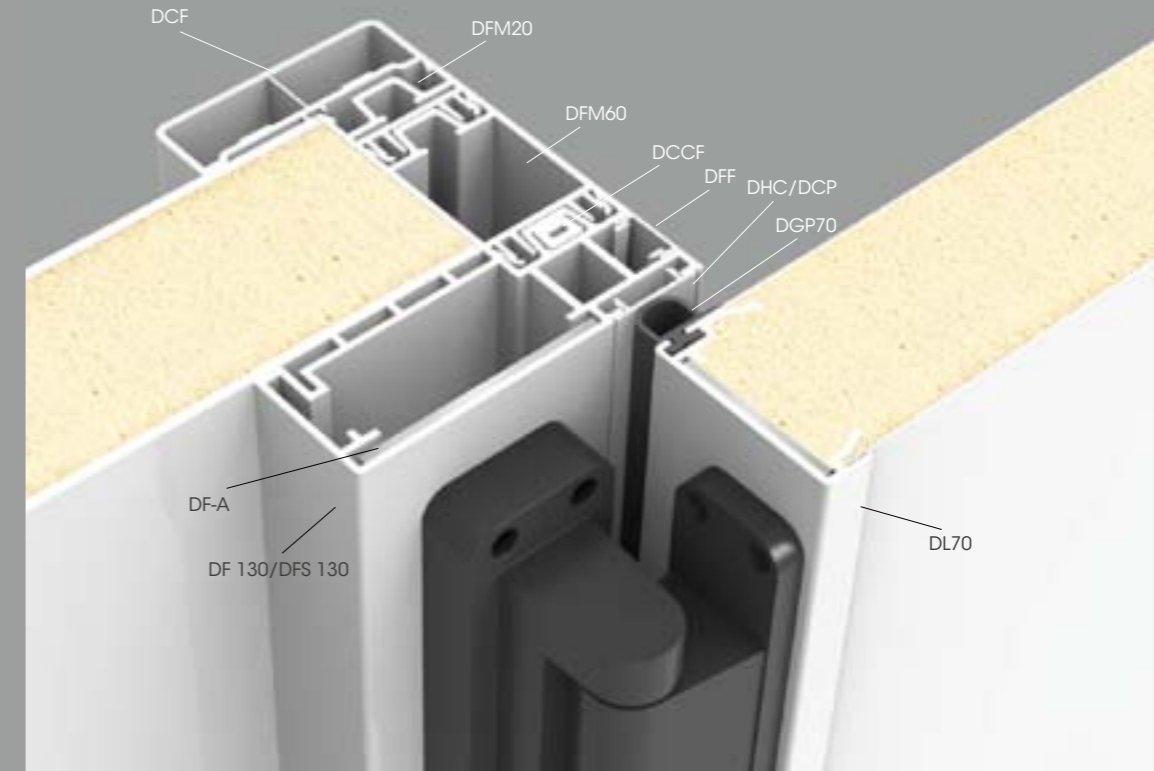

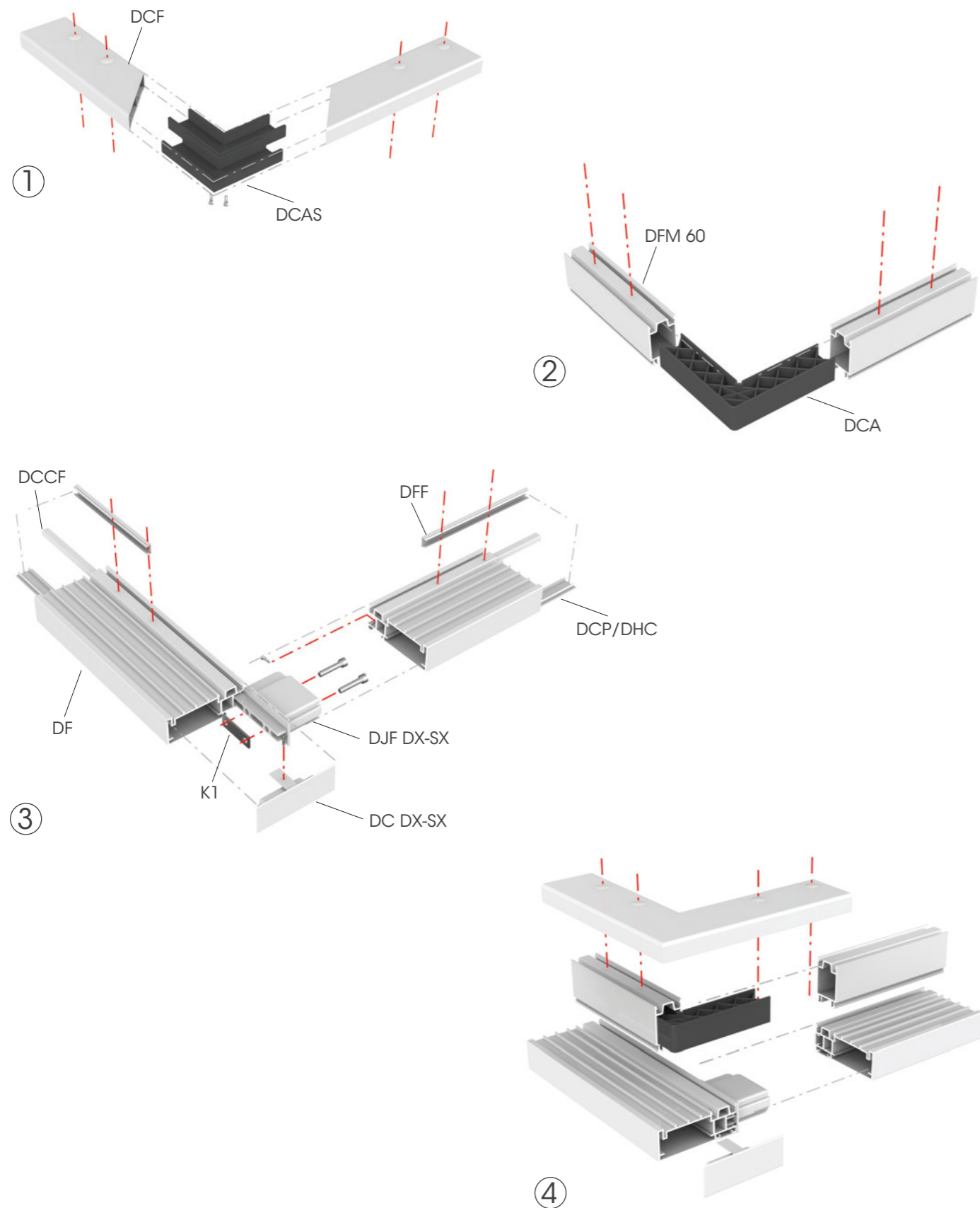

**DFL 110x80**

Length **5.800 mm**  
Packing **2 pz / bundle**  
Colour **E**

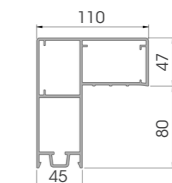

**DFL 130x60**



Length **5.800 mm**  
Packing **2 pz / bundle**  
Colour **E**

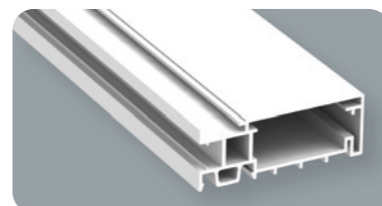
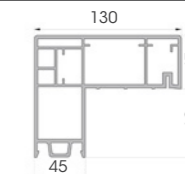

**DF 130**

Length **5.800 mm**  
Packing **2 pz / bundle**  
Colour **E**

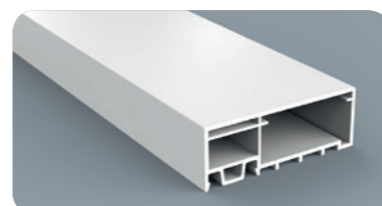
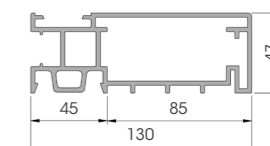

**DFS 130**



Length **5.800 mm**  
Packing **2 pz / bundle**  
Colour **E**

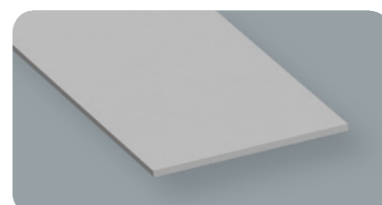
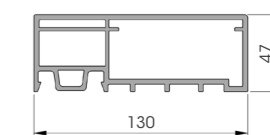

**DF-A**

Material **steel**  
Length **2.000 mm**  
Packing **2 pz / bundle**

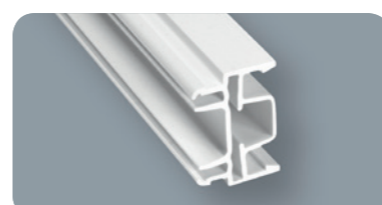
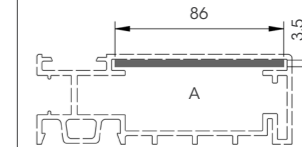

**DFM 20**

Length **5.800 mm**  
Packing **4 pz / bag**  
Colour **E**

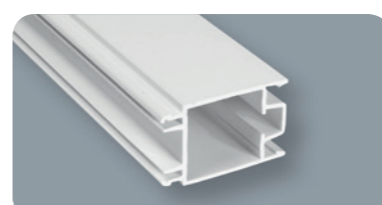
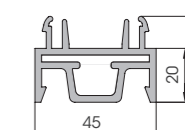

**DFM 60**

Length **5.800 mm**  
Packing **2 pz / bundle**  
Colour **E**

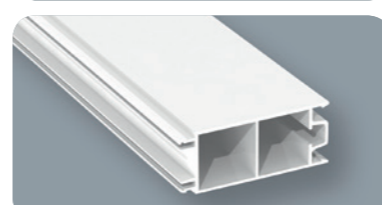
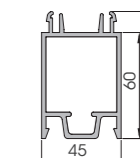

**DFM 100**

Length **5.800 mm**  
Packing **2 pz / bundle**  
Colour **E**

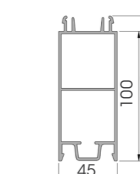

**DCF**

To install with TK 100 and TM 12

Length **5.800 mm**  
Packing **2 pz / bundle**  
Colour **E**

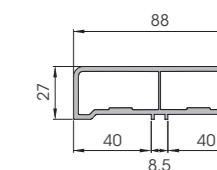

Door Frame



**DCCF**

Length **5.800 mm**  
Packing **25 pz / bundle**  
Colour **various**

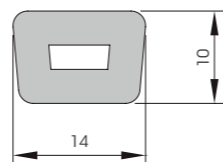

**DFF**

Length **5.800 mm**  
Packing **25 pz / bundle**  
Colour **E**

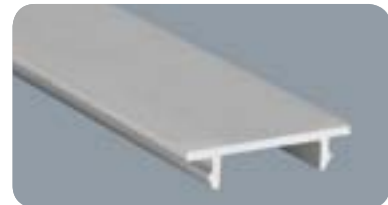
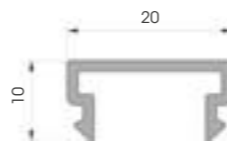

**DCP  
DHC**

Material **DCP plastic Ral 9010  
DHC aluminium**  
Length **5.800 mm**  
Packing **25 pz / bundle**

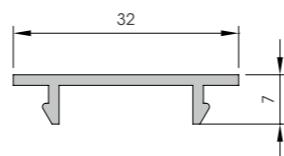

**DJF DX/SX**

Packing **10 pz / box**  
Colour **E**



**K1**

Material **steel**  
Packing **10 pz / bag**

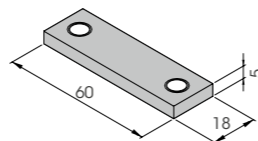

**DC DX/SX**

Packing **10 pz / box**  
Colour **E**

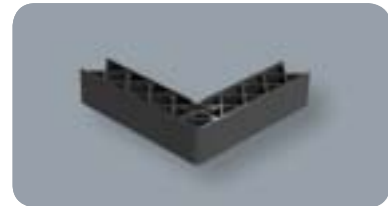

**DCA**

Packing **10 pz / box**  
Colour **D**

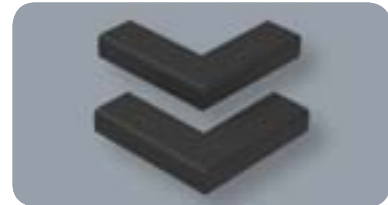
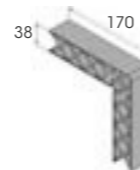

**DCAS**

Packing **20 pz / box**  
Colour **D**

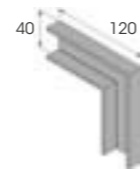

**RD**

Length **4.000 mm**  
Packing **25 pz / box**  
Colour **K**



Door Frame



**DW 60**

Length **4.000 mm**  
Packing **10 pz / bag**  
Colour **E K**

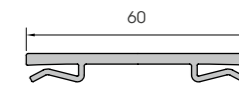

**DW 70**

Length **4.000 mm**  
Packing **10 pz / bag**  
Colour **E K**

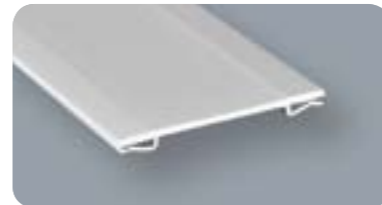
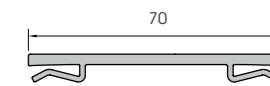

**DW 80**

Length **4.000 mm**  
Packing **10 pz / bag**  
Colour **E K**

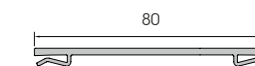

**DW 100**

Length **4.000 m m**  
Packing **10 pz / bag**  
Colour **E K**

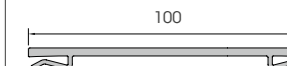



# DOOR LEAF

Door profiles for continuous panels and foamed panels. Available in aluminium and also in plastic to ensure thermal break

Linea di profili porta per pannelli in continuo e schiumati. Disponibili in alluminio, ma anche in plastica per garantire l'isolamento termico

Gamme de profilés pour portes frigorifiques à utiliser avec panneaux isolants réalisés par injection en continu de mousse polyuréthane. Ils sont disponibles en aluminium et aussi en matière plastique pour garantir l'isolation thermique.



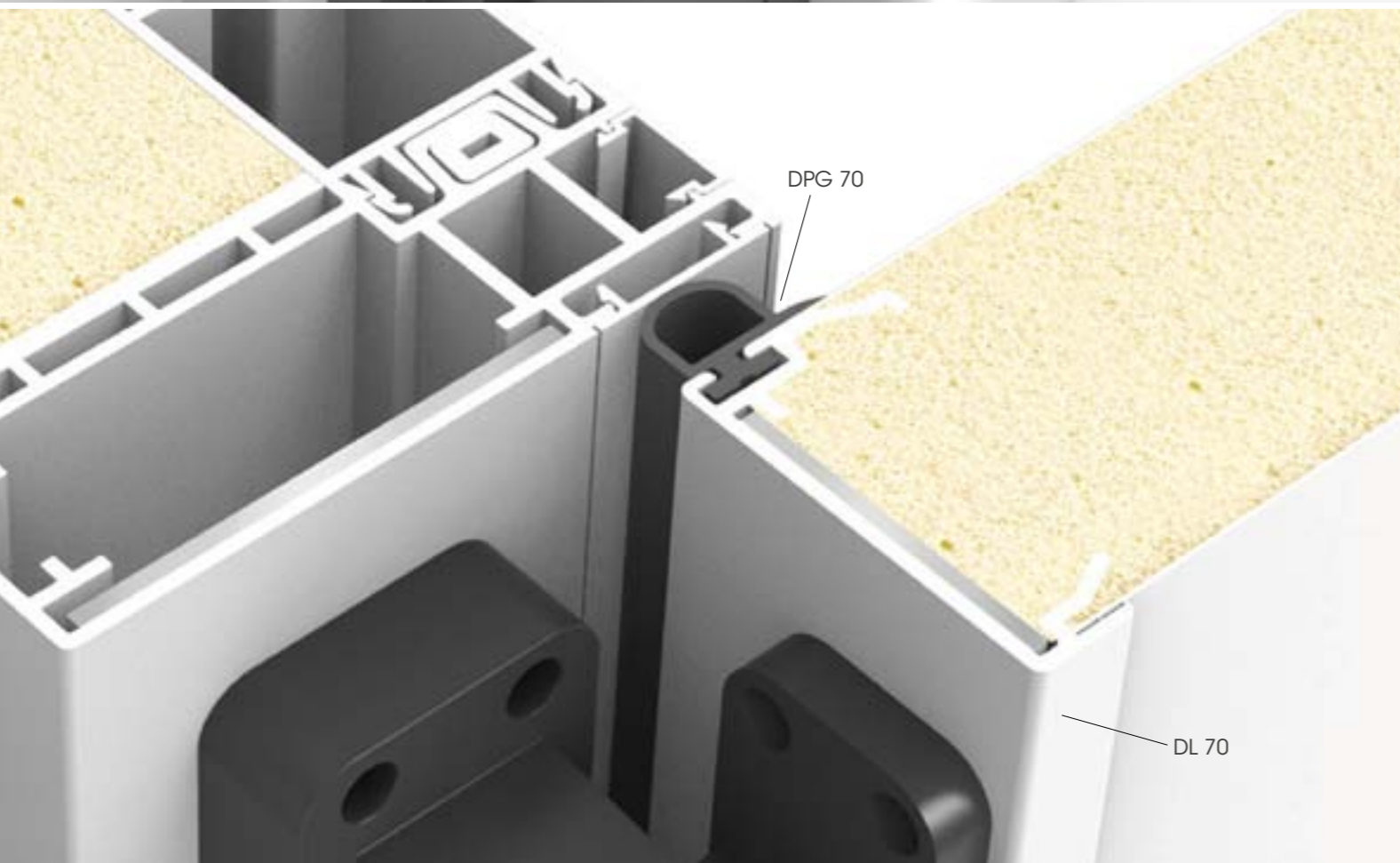
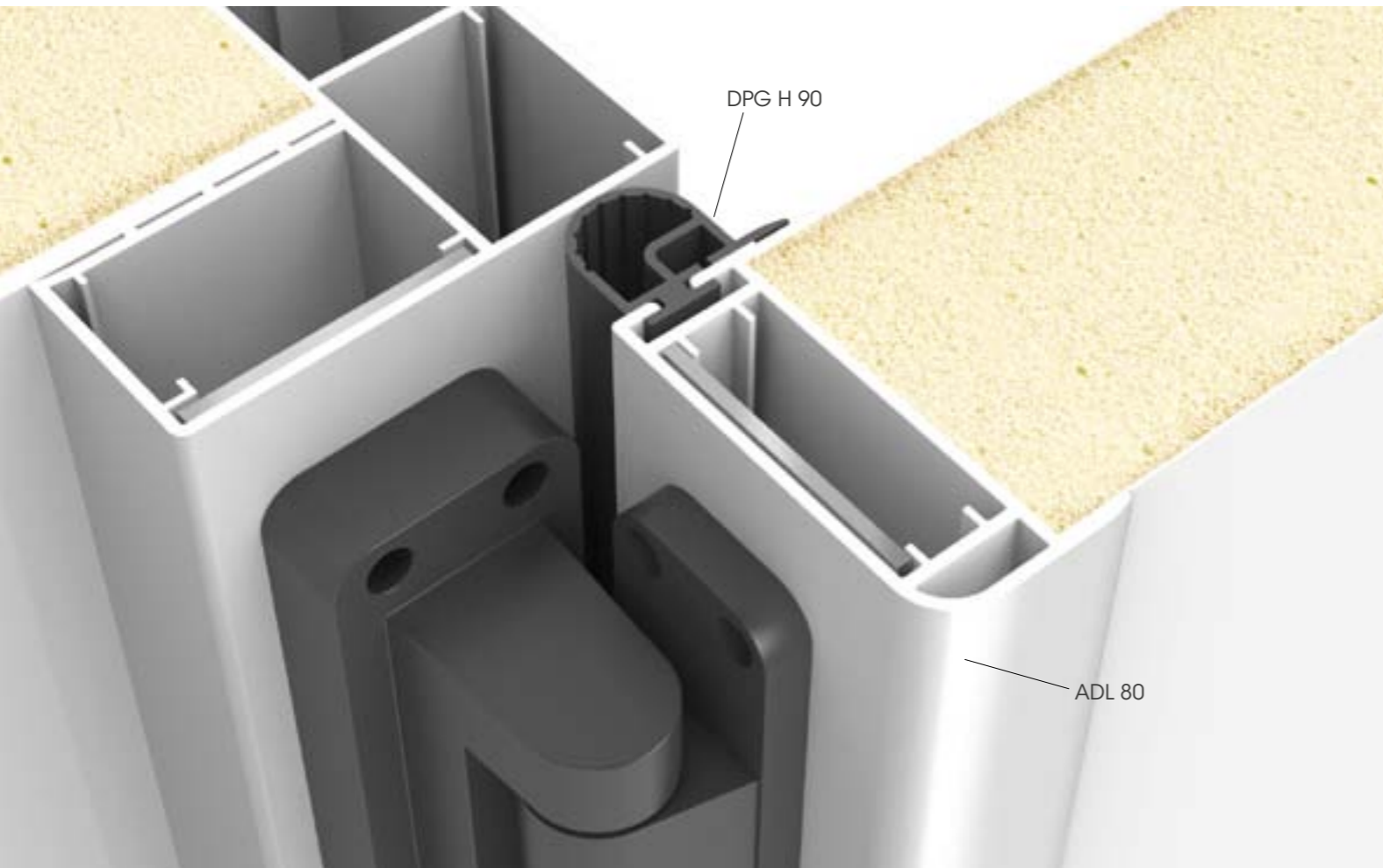

**ADL 80**  
To install with  
TM 12 - DPG 90 - DPGW 90  
DPGH 90 - DFG 90

Length **5.800 mm**  
Packing **to be defined**  
Colour **E**

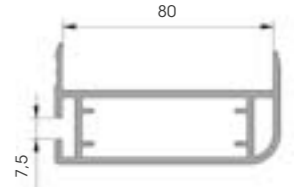

**SQ ADL**

Material **steel**  
Packing **to be defined**

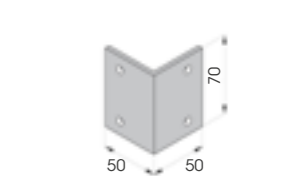

**DL 70**

Length **5.800 mm**  
Packing **2 pz / bag**  
Colour **E K**

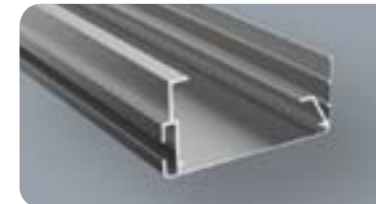
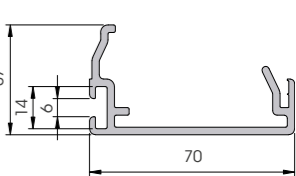

**DLALU 70**

Material **aluminium**  
Length **5.800 mm**  
Packing **to be defined**

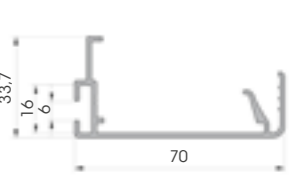

**DL 90**

Length **5.800 mm**  
Packing **2 pz / bag**  
Colour **E K**

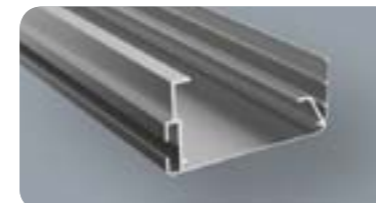
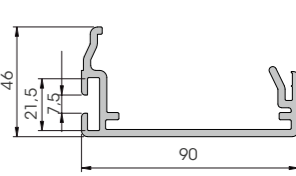

**DLALU 90**

Material **aluminium**  
Length **5.800 mm**  
Packing **to be defined**

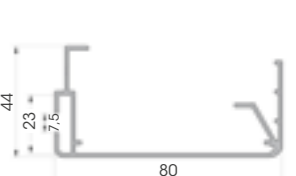

**DLFF40**

Length **5.800 mm**  
Packing **to be defined**  
Colour **E**

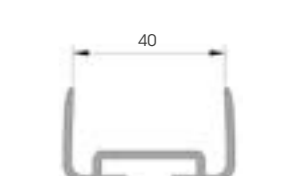



**DPG 70**

Packing 1 pz / reel  
L 80.000mm  
Colour **D**

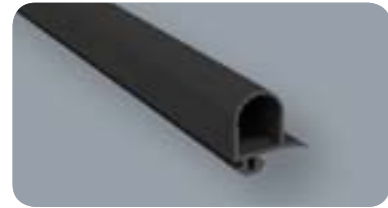
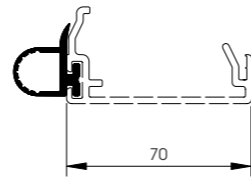

**DPG W 70**

Packing 1 pz / reel  
L 80.000mm  
Colour **D**

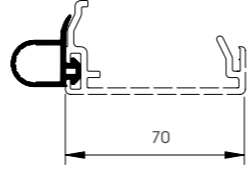

**ADPG 70**  
To install with DPG 70  
DPG W 70

Packing 50 pz / box  
Colour **D**



**DFG 70**

Length 3.800 mm  
Packing 12 pz / box  
Colour **D**

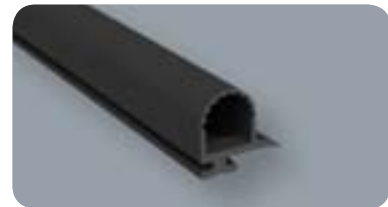
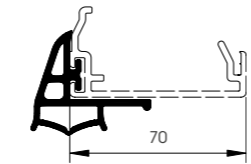

**DPG 90**

Packing 1 pz / reel  
L 50.000 mm  
Colour **D**

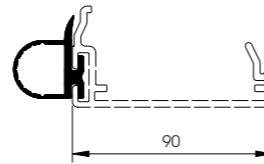

**DPG W 90**

Packing 1 pz / reel  
L 50.000 mm  
Colour **D**

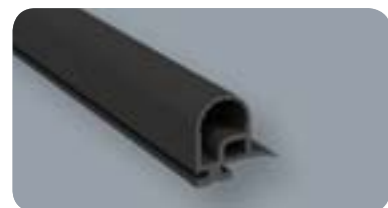
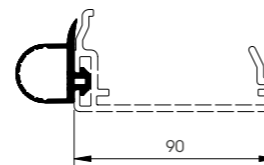

**DPG H 90**

Packing 1 pz / reel  
L 50.000 mm  
Colour **D**

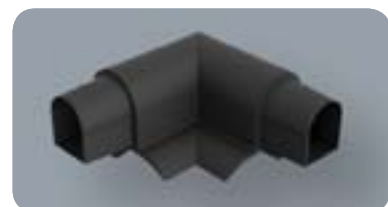
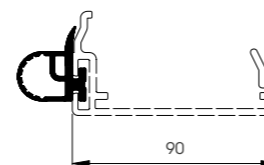

**ADPG 90**  
To install with DPG 90  
DPG W 90 - DPGH90

Packing 40 pz / box  
Colour **D**



**DFG 90**

Length 3.800 mm  
Packing 6 pz / box  
Colour **D**

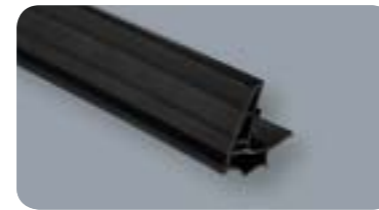
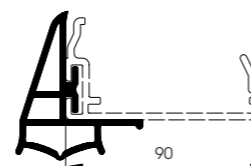

**VELA**

Length 3.700 mm  
Packing 6 pz / box  
Colour **D**

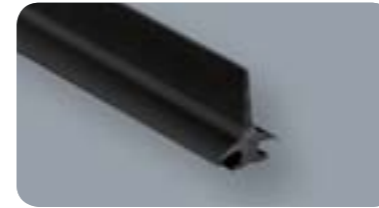
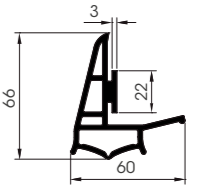

**PLANE**

Length 4.000 mm  
Packing 15 pz / box  
Colour **D**

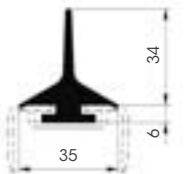

# 12

## ACCESSORIES FOR PANELS

Profiles and moulded accessories to complete the panel finish. Practical for cleaning assuring good hygiene for the food industry.

Profilati e stampati per completare la finitura di pannelli. Pratici per la pulizia e l'igiene nel settore alimentare.

Profilé et pièces injectés pour la finition des panneaux. Utiles pour assurer le nettoyage et l'hygiène dans le domaine alimentaire.



## Accessories for panels



### BAR 15

Breaking resistance with 660 Kg self-tapping screw  $\varnothing$  6,3 mm

Length **on request**  
Packing **boxes**  
Colour **E**

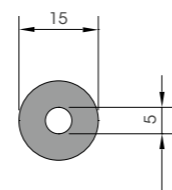

### AC40

Breaking resistance for meter 4970 Kg

Length **4.000 mm**  
Packing **4 pz / bundle**  
Colour **E**

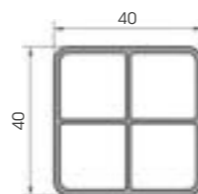

### AC 70

Breaking resistance for meter 5000 Kg

Length **4.000 mm**  
Packing **2 pz / bundle**  
Colour **E**

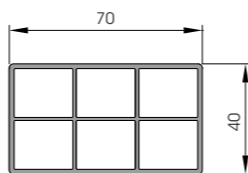

### ACT 70

Packing **100 pz / box**  
Colour **E**

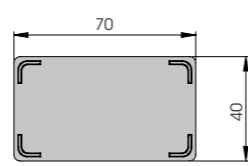

### MC 50

Length **4.000 mm**  
Packing **20 pz / box**  
Colour **E**

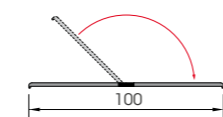

### L 120x60

Length **4.000 mm**  
Packing **to be defined**  
Colour **E**

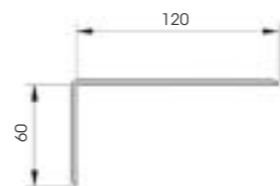

### SH 40

Length **4.000 mm**  
Packing **32 pz / box**  
Colour **E**

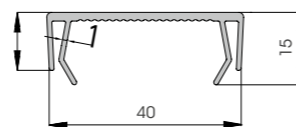

### SH 60

Length **4.000 mm**  
Packing **25 pz / box**  
Colour **E**

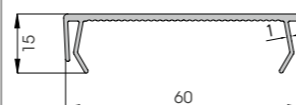

### R 60

Packing **300 pz / box**  
Colour **E F**

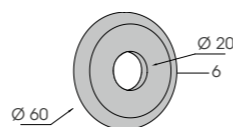

## Accessories for panels



### R 90

Available with hole  $\varnothing$  14/20 mm

Packing **150 pz / box**  
Colour **E F**

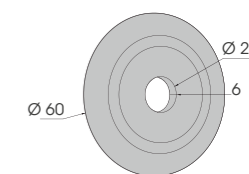

### M 8

Breaking resistance 790 Kg

### M 10

Breaking resistance 520 Kg

### M 12

Breaking resistance 980 Kg

Packing **300 pz / box**  
Colour **E F**

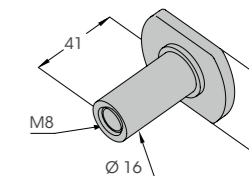

### M 8H

### M 10H

### M 12H

Packing **300 pz / box**  
Colour **E F**

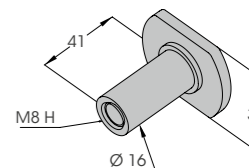

### M 10 SI

Breaking resistance 1.000 Kg



Packing **300 pz / box**  
Colour **E F**

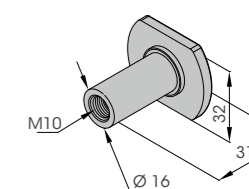

### DAD 12

Packing **1.000 pz / box**  
Colour **White**



### BAR 12

Length **500 mm**  
Packing **100 pz / box**  
Colour **White**

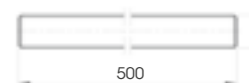

### RON 12

Packing **100 pz / box**  
Colour **White**

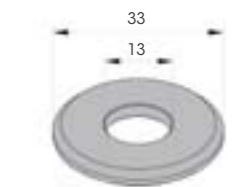

# 13

## TRIMS

Complete range of profiles and accessories used to fix and to finish panels.

Gamma completa di profili e accessori per l'incastro e la finitura dei pannelli.

Gamme complète de profilés et d'accessoires pour le joint et la finition de panneaux.



Trims



**PCC**

Length **2.500 / 3.000 mm**  
Packing **30 pz / box**  
Colour **E**

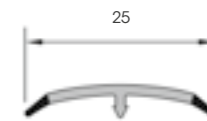

**PCB**

Length **2.500 / 3.000 mm**  
Packing **30 pz / box**  
Colour **White**

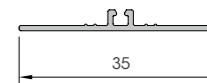

**PCS**

Length **2.500 / 3.000 mm**  
Packing **150 pz / box**  
Colour **E**

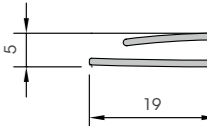

**PDB**

Length **2.500 / 3.000 mm**  
Packing **100 pz / box**  
Colour **E**

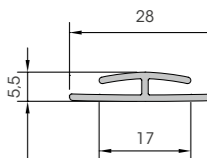

**PCI**

Length **2.500 / 3.000 mm**  
Packing **100 pz / box**  
Colour **E**

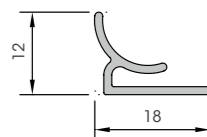

**PCO**

Length **2.500 / 3.000 mm**  
Packing **100 pz / box**  
Colour **E**

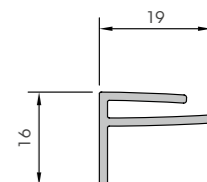

# 14

## T SUSPENSION

**CERTIFICATED  
BREAKING RESISTANCE**



T and Omega profiles for ceiling suspension. White painted aluminium profiles, fire resistance and equipped with stainless steel nuts covered in plastic to ensure thermal bridge. Two solutions available, one light and one heavy.

Profili a T e Omega per soffitto a sospensione. Realizzati in alluminio verniciato bianco, resistenti al fuoco e provvisti di dadi in acciaio ricoperti in plastica che fungono da taglio termico. Disponibili 2 soluzioni, una leggera e una pesante.

T et Omega profilés pour la suspension de plafond. Blanc laqué profilés en aluminium, résistants au feu et équipés d'écrous en acier inox recouverts de plastique pour garantir le pont thermique. Deux solutions disponibles, une légère et une lourde.



## T Suspension



**T 85**

Length **4.000 mm**  
Packing **2 pz / bundle**  
Colour **E F**

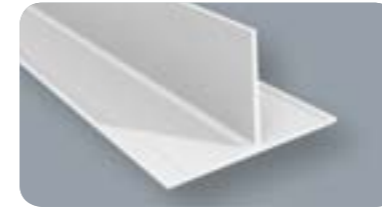
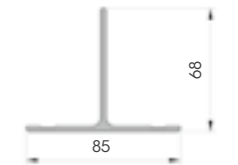

**T 130**

Length **4.000 mm**  
Packing **2 pz / bundle**  
Colour **E F**

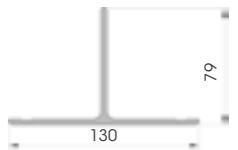

**OME 110**

Length **4.000 mm**  
Packing **5 pz / bundle**  
Colour **E F**

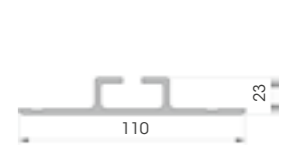

**OME 150**

Length **4.000 mm**  
Packing **2 pz / bundle**  
Colour **E F**

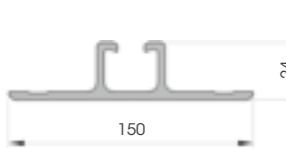

**CEBES 100**

Length **4.000 mm**  
Packing **5 pz / bundle**  
Colour **E F**



**CEBES 130**

Length **4.000 mm**  
Packing **3 pz / bundle**  
Colour **E F**



**OMES L**

**STEEL INSERT** **PLASTIC COATING**

Packing **50 pz / box**  
Colour **E**

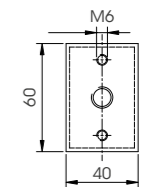

**OMES S**

**STEEL INSERT** **PLASTIC COATING**

Packing **50 pz / box**  
Colour **E**

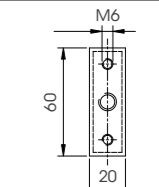

**SJ8  
SJ10  
SJ12**

Material **galvanized steel**  
Packing **50 pz / box**

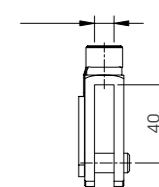

# 15

## RACK PROTECTION

Complete range of PVC profiles to protect the warehouse racks. Equipped with accessories and shock resistant to trolleys and forklifts impacts.

Completa gamma di profili in PVC per la protezione delle scaffalature nei magazzini e depositi. Completi di accessori e resistenti agli urti di muletti e transpallets.

Complète gamme de profilés en PVC pour la protection d'étagères de dépôts. Complete d'accessoires et résistant aux mouvements de chariots et chariots élévateurs.

OUR PROFILES  
FIT ALL RACKS



UNIVERSAL

EASY TO INSTALL



### RPF 600

Equipped with accessories

60 130



Packing Colour **to be defined**



### RPS 600

60 80



Packing Colour **to be defined**

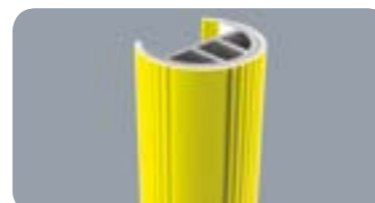
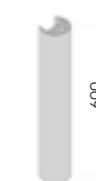

### RPM 600

80 100



Packing Colour **to be defined**

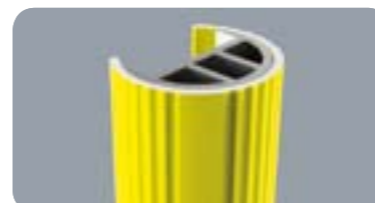
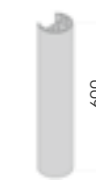

### RPL 600

100 120



Packing Colour **to be defined**





# 16

## GUARD RAIL

A new bumper system specific for the protection of the walls resistant against trolleys impacts. Designed by following an innovative technical design that combines speed and simplicity in the steps of installation and cleaning. Available in different lengths.

Sistema profili antiurto specifico per la protezione delle pareti contro l'urto dei transpallet. Progettato seguendo un innovativo disegno tecnico che coniuga rapidità e semplicità nelle fasi di installazione e pulizia. Disponibile in diverse lunghezze.

Nouveau système bumper, spécifique pour protéger les murs contre les mouvements des charriots. Étudié avec un modern dessin qui regroupe la rapidité et la facilité pendant l'installation et le nettoyage. Disponible en différents longueurs.

New colours available



### GRD 90/150

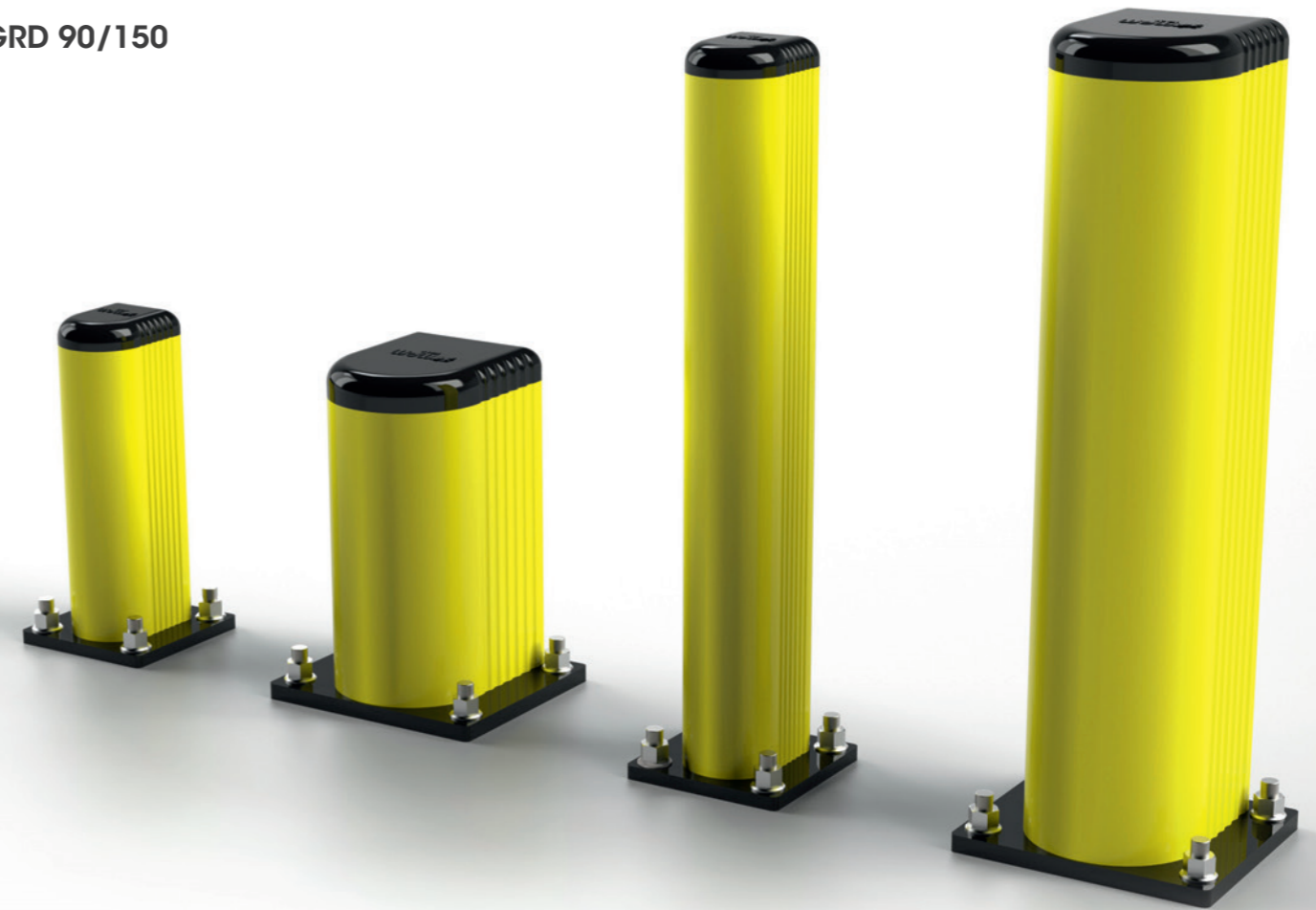

**GRD 90 250**  
Equipped with accessories

Packing Colour **to be defined**  
C

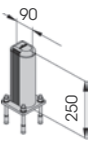

**GRD 90 500**  
Equipped with accessories

Packing Colour **to be defined**  
C

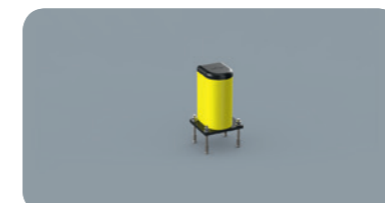
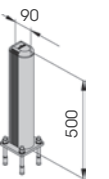

**GRD 150 250**  
Equipped with accessories

Packing Colour **to be defined**  
C

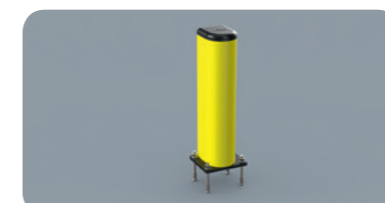
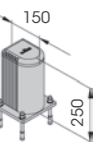

**GRD 150 500**  
Equipped with accessories

Packing Colour **to be defined**  
C

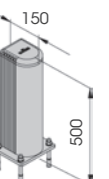

**GUARD RAIL 90**

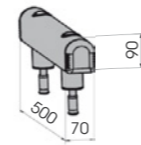

**GR 90 500**  
Equipped with accessories  
Length **500 mm**  
Packing **4 pz / box**  
Colour **C**

**GR 90 1000**  
Equipped with accessories  
Length **1.000 mm**  
Packing **2 pz / box**  
Colour **C**

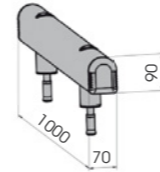

**GR 90 2000**  
Equipped with accessories  
Length **2.000 mm**  
Packing **2 pz / box**  
Colour **C**

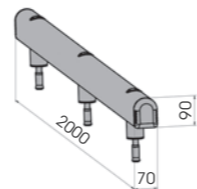

**GR 90 3000**  
Equipped with accessories  
Length **3.000 mm**  
Packing **2 pz / box**  
Colour **C**

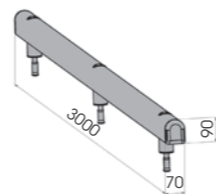

**GR 90 4000**  
Equipped with accessories  
Length **4.000 mm**  
Packing **to be defined**  
Colour **C**

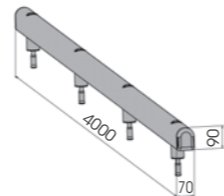

**GR 90 P 500-1000  
2000-3000  
4000**  
Length **500 / 1000 / 2.000  
3.000 / 4.000 mm**  
Packing **to be defined**  
Colour **C**

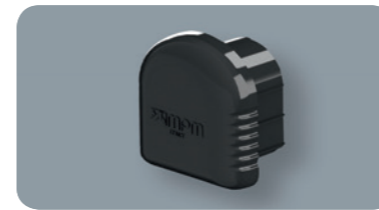
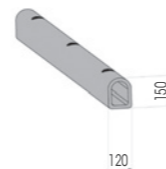

**GRT 90**

Packing **50 pz / box**  
Colour **D**

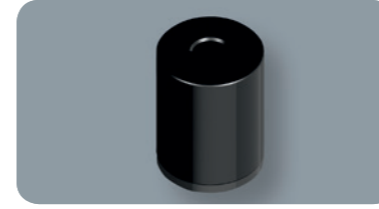
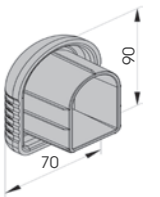

**GRS 90**

Equipped with sponge

Packing **200 pz / box**  
Colour **D**

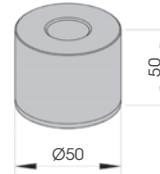

**AF 16**  
Ø 16

Material **galvanized steel**  
Packing **to be defined**

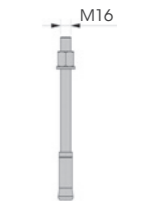

**GRC 90**

Packing **100 pz / box**  
Colour **A D**

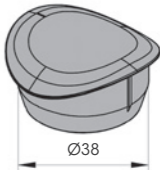

**FENCE 90**



**FE 1100x350**

Equipped with accessories

Length **1.100 mm**  
Packing **to be defined**  
Colour **C**

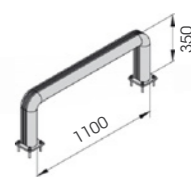



**FE 2400x350**  
Equipped with accessories

Length **2.400 mm**  
Packing **to be defined**  
Colour **C**

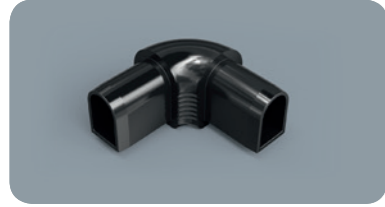

**GRA 90**

Packing **to be defined**  
Colour **B D**

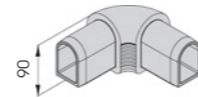

**FIX P90**

Material **galvanized steel**  
Packing **to be defined**

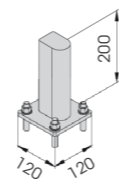

**COLUMN PROTECTION 90**

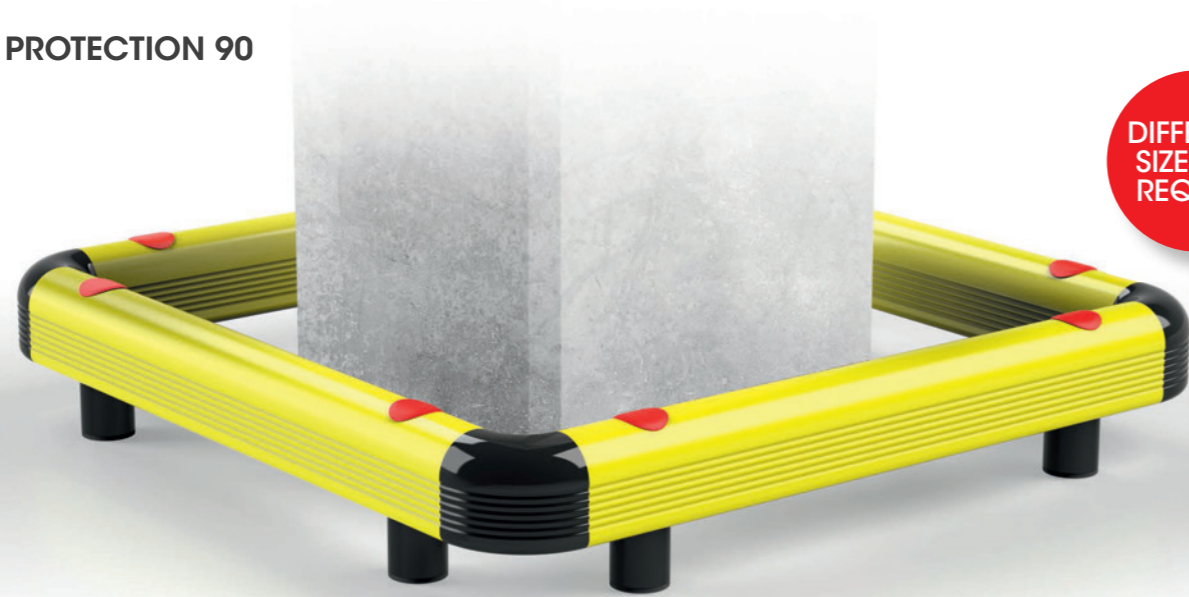

**DIFFERENT SIZES ON REQUEST**

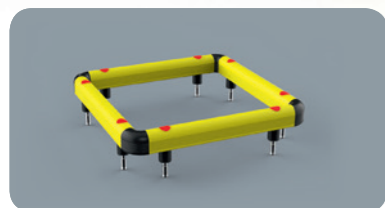

**COPRO 500x500**  
Equipped with accessories

Packing **to be defined**  
Colour **C**

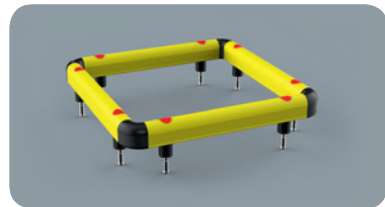
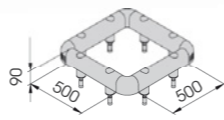

**COPRO 600x600**  
Equipped with accessories

Packing **to be defined**  
Colour **C**

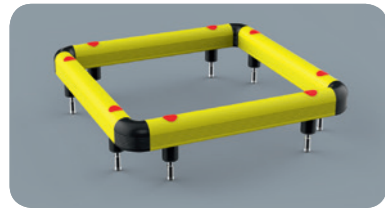
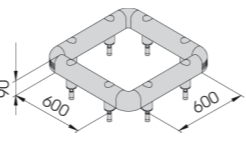

**COPRO 700x700**  
Equipped with accessories

Packing **to be defined**  
Colour **C**

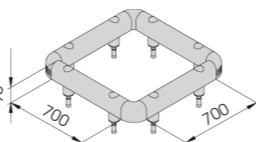

**GUARD RAIL 150**

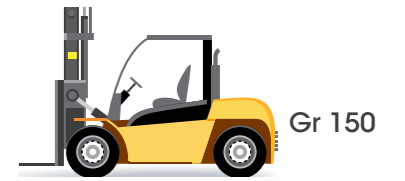
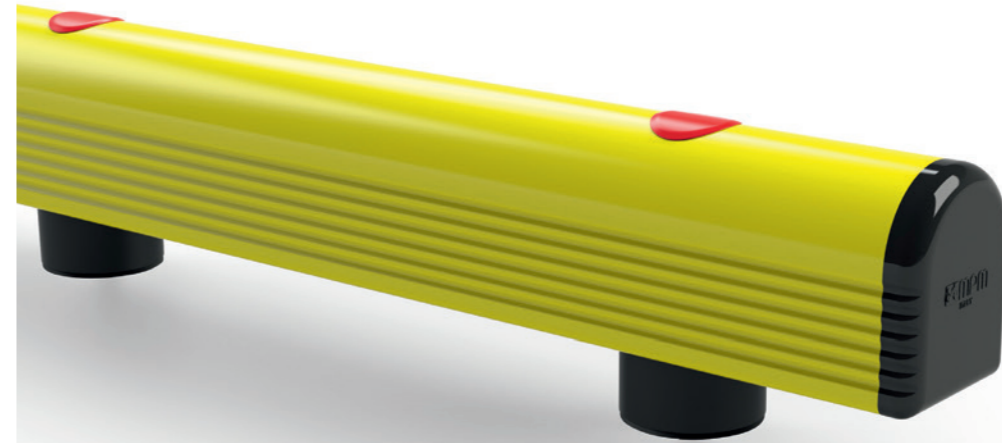

**GR 150 500**  
Equipped with accessories

Length **500 mm**  
Packing **to be defined**  
Colour **C**

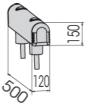

**GR 150 1000**  
Equipped with accessories

Length **1.000 mm**  
Packing **to be defined**  
Colour **C**

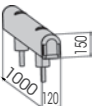

**GR 150 2000**  
Equipped with accessories

Length **2.000 mm**  
Packing **to be defined**  
Colour **C**

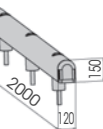

**GR 150 3000**  
Equipped with accessories

Length **3.000 mm**  
Packing **to be defined**  
Colour **C**

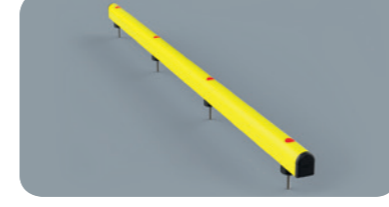
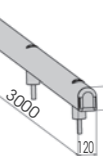

**GR 150 4000**  
Equipped with accessories

Length **4.000 mm**  
Packing **to be defined**  
Colour **C**

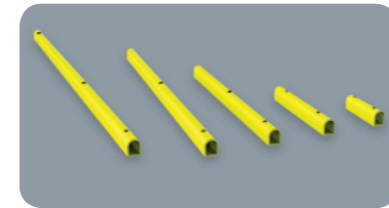
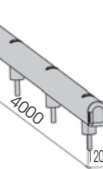

**GR 150 P 500-1000  
2000-3000  
4000**

Length **500 / 1.000 / 2.000  
3.000 / 4.000 mm**  
Packing **to be defined**  
Colour **C**



# Guard Rail

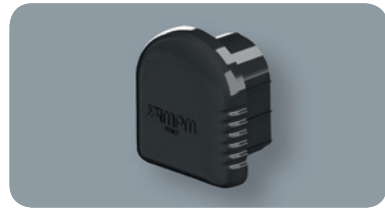

**GRT 150**

Packing 20 pz / box  
Colour **D**

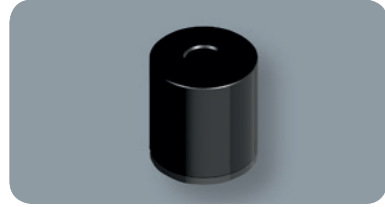
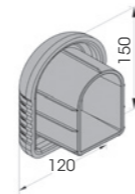

**GRS 150**

Equipped with sponge

Packing 50 pz / box  
Colour **D**

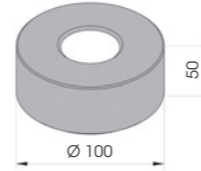

**SF 20**

Material **galvanized steel**  
Packing to be defined



**GRC 150**

Packing 100 pz / box  
Colour **A D**

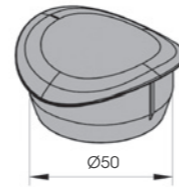

# Guard Rail

## PEDESTRIAN 90



**GR90 HV**  
With holes

Length 1.100 mm  
Packing to be defined  
Colour to be defined

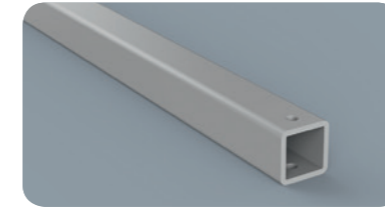
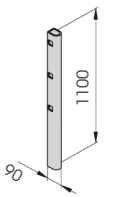

**SQ 40x40 HO**  
With holes

Length 1.500 mm  
Packing to be defined  
Colour to be defined

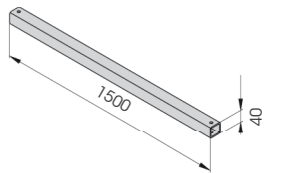

**FIX P90**  
Equipped with accessories

Material **galvanized steel**  
Packing to be defined

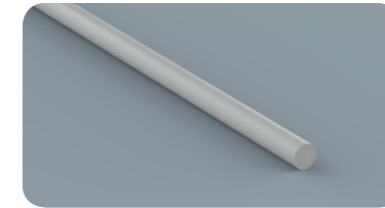
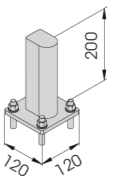

**CON 90**

Packing to be defined

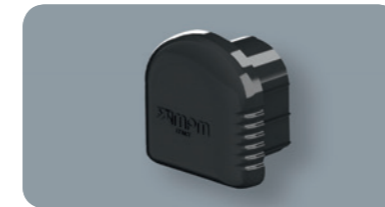
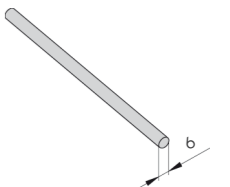

**GRT 90**

Packing 50 pz / box  
Colour **D**

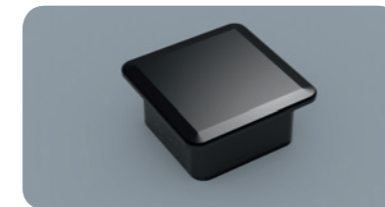
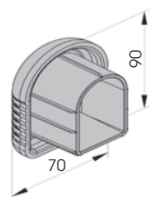

**PEC 90**

Packing to be defined  
Colour to be defined

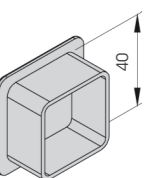

# Guard Rail

## PEDESTRIAN 150



**GR150 HV**  
With holes

Length **1.100 mm**  
Packing **to be defined**  
Colour **to be defined**

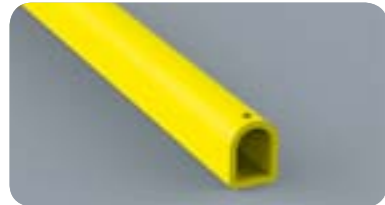

**GR90 HO**  
With holes

Length **1.500 mm**  
Packing **to be defined**  
Colour **to be defined**

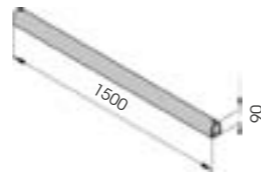

**FIX P150**  
Equipped with accessories

Material **galvanized steel**  
Packing **to be defined**

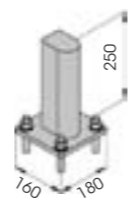

**CON 150**

Packing **to be defined**

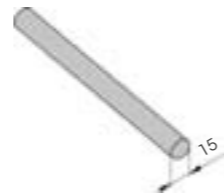

**GRT 150**

Packing **20 pz / box**  
Colour **D**



**PEC 150**

Packing **to be defined**  
Colour **to be defined**

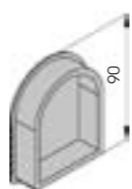

# 17 BUMPER 30

Small bumper to be used on refrigerated cabinets and check-outs, easy set up for installing profiles on pvc guide, available in soft or rigid pvc.

Paracolpi di piccole dimensioni ideale per vetrine refrigerate e check outs, facile da installare con rapido fissaggio tramite incastro su guida in pvc, disponibile in materiale rigido o morbido.

Profilé anti-choc de petits dimensions idéal pour les vitrines réfrigérées et les compteurs, facile à installer avec fixation rapide par le support en pvc disponible en matériel dur ou souple.

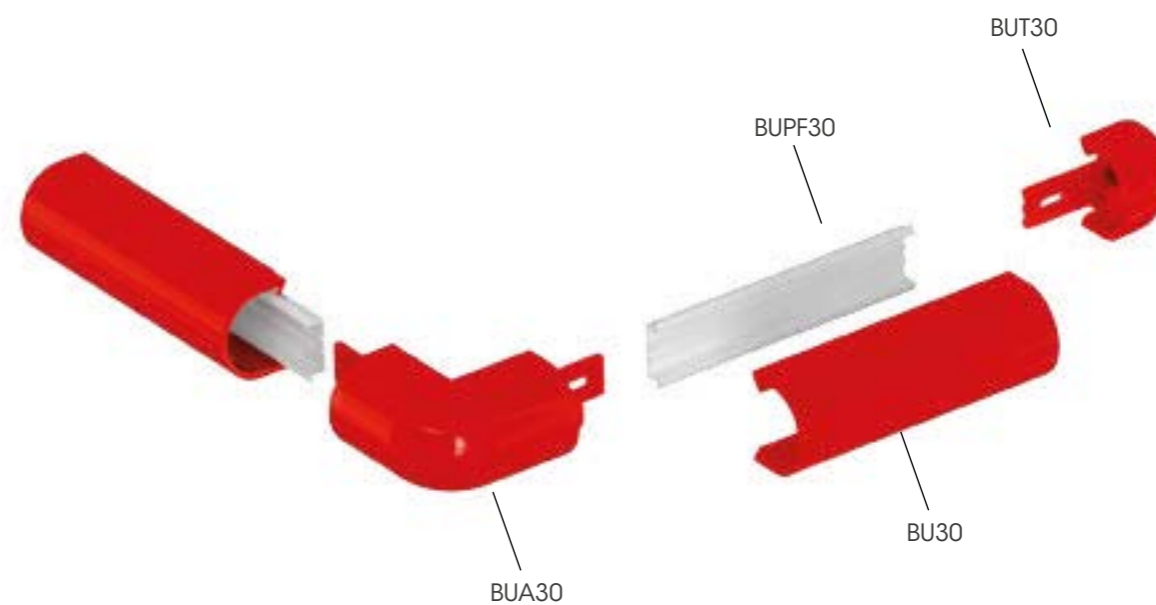

**BU 30**

Length **4.000 mm**  
Packing **22 pz / box**  
Colour **A B C D E G H**

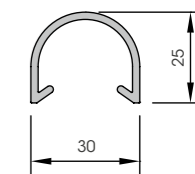

**BU 30 flex**

Minimum radius: 60 mm

Packing **2 pz / box**  
L = **22.000 mm**  
Colour **A B C D E F G H I J**

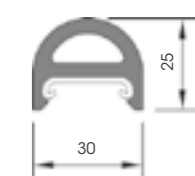

**BUPF 30**

Length **4.000 mm**  
Packing **22 pz / box**

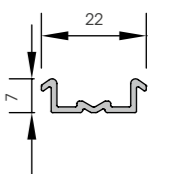

**BUT 30**

Packing **100 pz / box**  
Colour **A B C D E F G H I J**

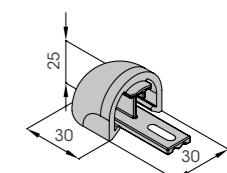

**BUA 30**

Packing **50 pz / box**  
Colour **A B C D E F G H I J**

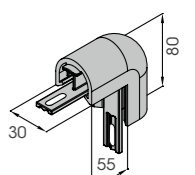

# 18

## BUMPER 50

Highly resistant against impacts, linear but functional design, high resistant, easy to install and equipped with accessories.

Profilo paracolpi dal design semplice e funzionale. Resistente, facile da installare e completo di accessori.

Profilé anti-choc avec un design simple et fonctionel. Résistant, facile à installer et fourni entièrement équipé.

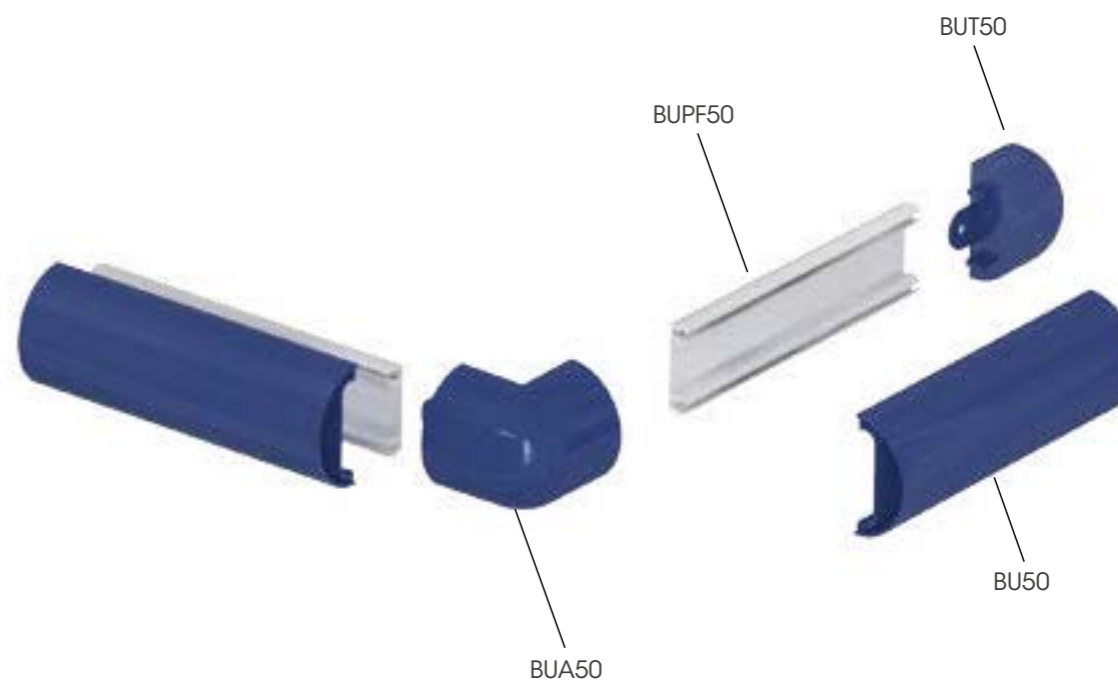

**BU 50**

Length 4.000 mm  
Packing 14 pz / box  
Colour 

A	B	C	D
E	G	H	

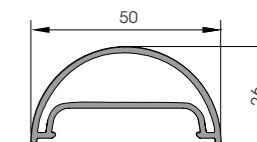

**BU 50 flex**

Minimum radius: 250 mm

Length 4.000 mm  
Packing 14 pz / box  
Colour 

A	B	C	D	E
F	G	H	I	J

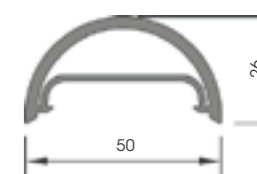

**BUPF 50**

Length 4.000 mm  
Packing 14 pz / box

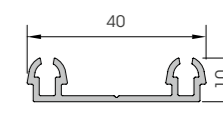

**BUT 50**

Packing 100 pz / box  
Colour 

A	B	C	D	E
F	G	H	I	J

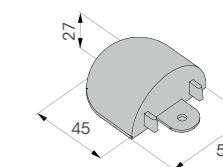

**BUA 50**

Packing 50 pz / box  
Colour 

A	B	C	D	E
F	G	H	I	J

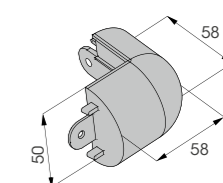

# 19

## BUMPER 80

Without guides, this profile is directly fixed to the wall through hidden screws covered by a specific item available in various colours.

Articolo paracolpi a fissaggio diretto alla parete tramite viti nascoste da un apposito profilo disponibile in vari colori.

Profilé anti-choc à fixation directe aux murs grâce à des vis cachées par un profilé disponible en plusieurs couleurs.

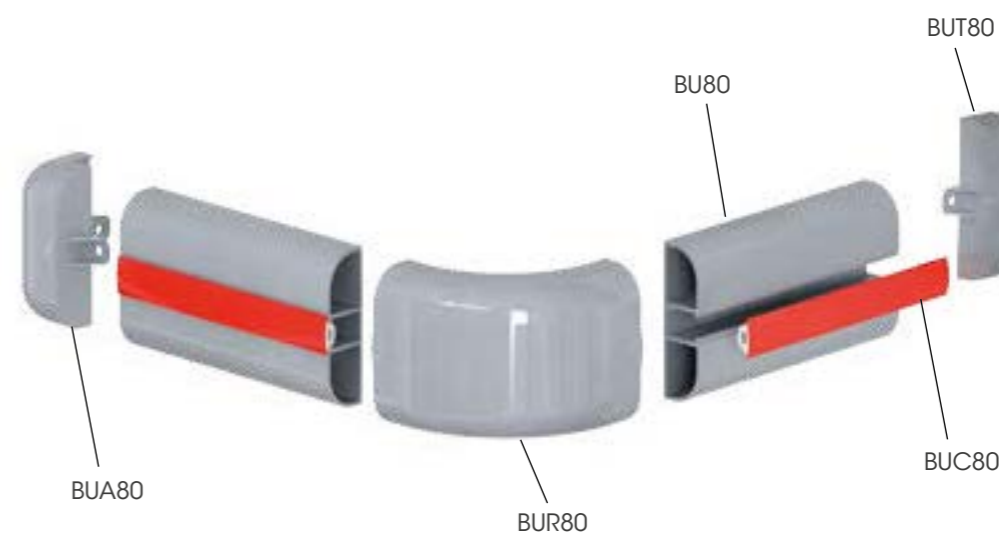

**BU 80**

Length **4.000 mm**  
Packing **6 pz / box**  
Colour **B E**

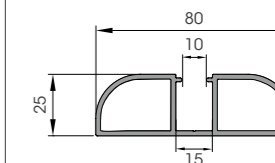

**BUC 80**

Length **60 mt / reel**  
Packing **cardboard reel**  
Colour **A B C D E G H**

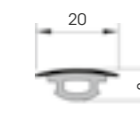

**BUT 80**

Packing **50 pz / box**  
Colour **B E**

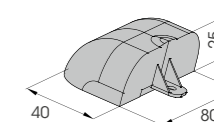

**BUA 80**

Packing **50 pz / box**  
Colour **B E**

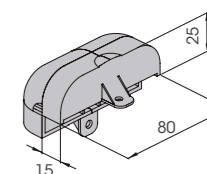

**BUR 80**

Packing **25 pz / box**  
Colour **B E**

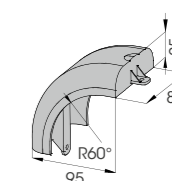



# 20

# BEND 80

Unique in range and shape,  
a forceful choice between  
convenience and stylish design.  
Corner caps are not necessary.

Articolo unico nel suo genere,  
compromesso tra praticità  
e design elegante. Si adatta alla  
parete senza l'ausilio di raccordi.

Article unique en son genre,  
parfait compromis entre la praticité  
et le design élégant. Il s'adapte  
au mur sans avoir besoin d'embouts  
supplémentaires.

PATENTED  
BREVETTATO

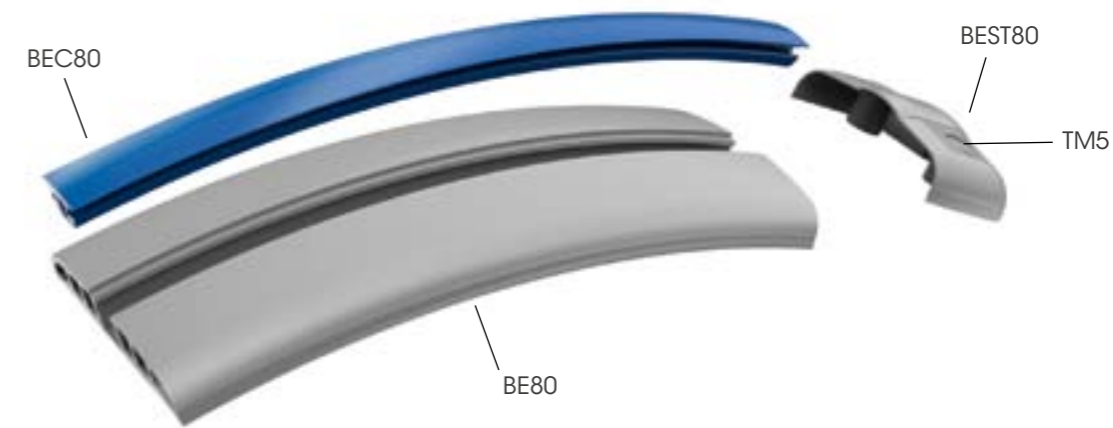

**BES 80**  
With double-sided tape  
Minimum radius: 40 mm

Packing 1 pz / box  
L= 25.000 mm  
Colour T  
+ colored strip  
A G I

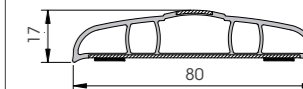

**BED 80 with tape**  
**BE 80 with screws**  
Minimum radius: 40 mm

Packing 1 pz / box  
L = 25.000 mm  
Colour T

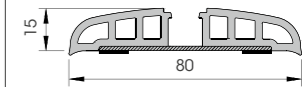

**BER 80**

Length 4.000 mm  
Packing 15 pz / box  
Colour B



**BEC 80**

Length 60 mt / reel  
Packing cardboard reel  
Colour A B C D E  
F G H I J

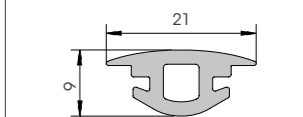

**BEST 80**  
To install with TM5

Packing 50 pz / box  
Colour B I

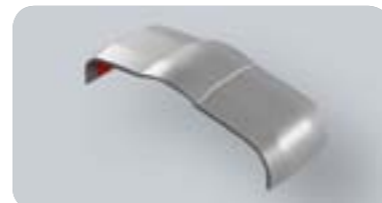
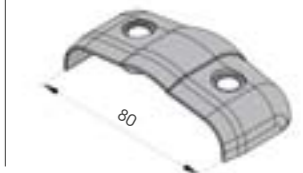

**BEJ 80**  
With double-sided tape

Packing 50 pz / box  
Colour T

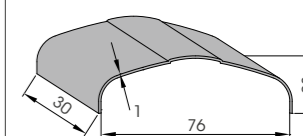

# 21

## BUMPER SUPERFLEX 80

New flexible model of classic BU80, produced in coextruded material, features versatility and elegance, easy to install and shockproof.

Nuovissima versione del classico BU 80, prodotto in materiale coestruso, coniuga versatilità ed eleganza alle immancabili doti tecniche quali facilità di montaggio e resistenza all'urto.

Nouvelle version de classique BU80, produit en matériel co-extrudé, mélange polyvalence et élégance aux caractéristiques techniques tels que la facilité à l'assemblage et la résistance aux chocs.



### Bumper Superflex 80

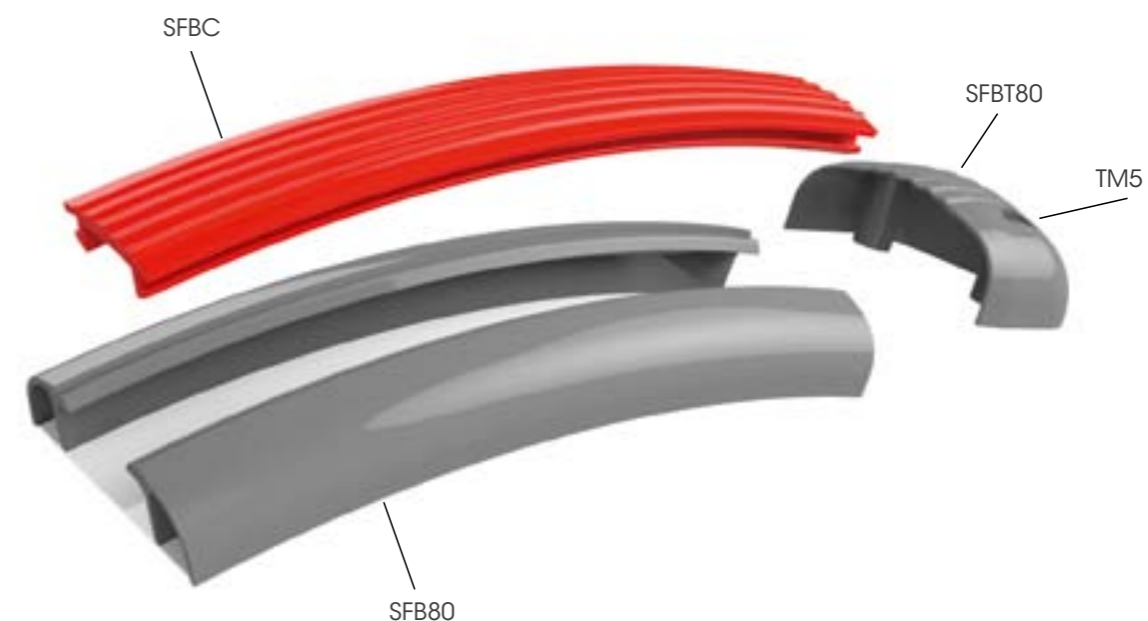

**SFB 80**

Packing **1 pz / box**  
L = 10.000 mm  
Colour **I J**

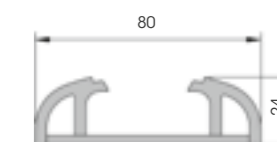

**SFRB 80**

Length **4.000 mm**  
Packing **5 pz / box**  
Colour **B**

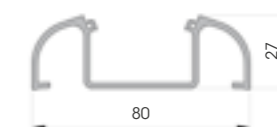

**SFBC**

Packing **2 pz / box**  
L = 40.000 mm  
Colour **A G I J**

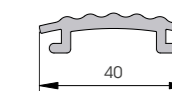

**SFBT80**

To install with TM5

Packing **50 pz / box**  
Colour **B I J**

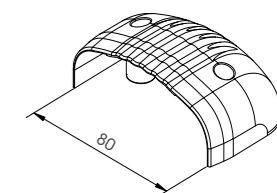

# 22

## BUMPER SPONGEGUM

PATENTED  
BREVETTATO



New bumper system of high performance, produced with soft plastic and specific spongy material inside, which ensure good resistance to impacts, thermal and acoustic insulation, water resistance and energy absorption

Nuova linea di paracolpi morbido ad alta prestazione con all'interno un particolare materiale spugnoso che garantisce resistenza agli urti, buon isolamento termico e acustico, resistenza all'acqua, assorbimento energetico

Système complet pour les portes coulissantes en vitre de vitrines réfrigérées. Profilés en pvc antichoc équipés d'accessoires pour assurer une bonne isolation et donc une économie d'énergie considérable. A rail inférieur est installé pour permettre le coulissement pratique de l'ouverture et la fermeture des portes.



**SPO 80**  
With double-sided tape

Length **4.000 mm**  
Packing **to be defined**  
Colour **T J**

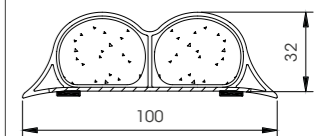

**SPOT 80**

Packing **to be defined**  
Colour **T J**

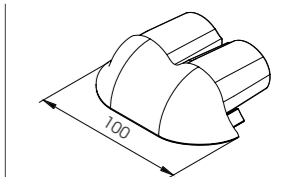

# 23

## BUMPER MODULAR

New modular antischock profile with hidden screws. You can enlarge the protecting surface by adding simple profiles, economic and easy to clean.

Nuovo profilo paracolpi modulare con viti a scomparsa. Possibilità di aumentare la superficie di protezione con l'aggiunta di semplici profili, economico e facile da pulire.

Nouveau profilé modulable anti-choc avec attaches cachées. Vous pouvez élargir le profilé et la surface protégée en ajoutant simplement des profilés, économique et facile à nettoyer.



### Bumper Modular

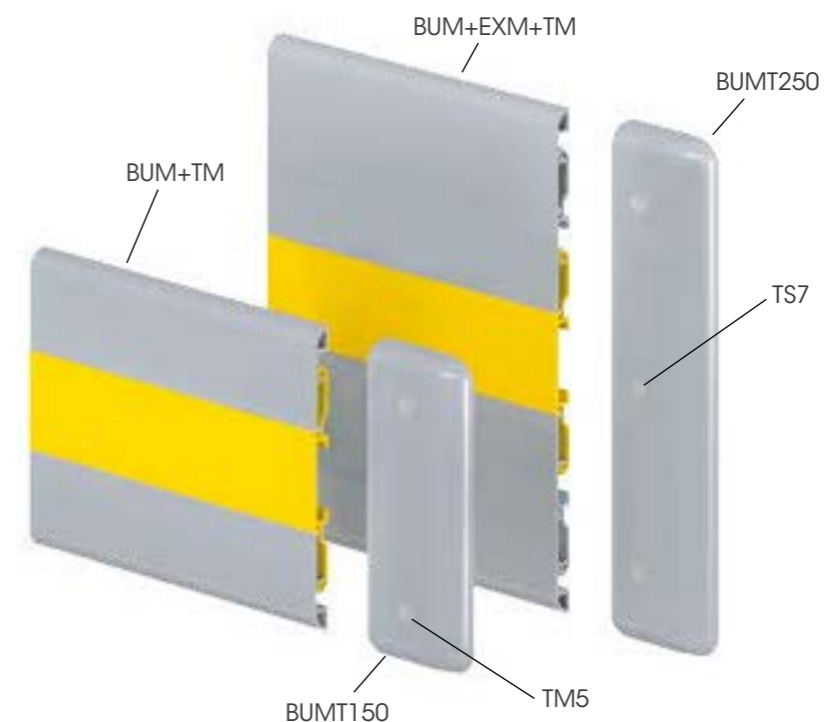

#### BUM

Length **4.000 mm**  
Packing **8 pz / box**  
Colour **A B C E G H**

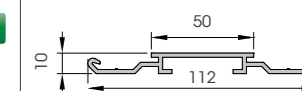

#### TM

Length **4.000 mm**  
Packing **40 pz / box**  
Colour **B E**



#### EXM

Length **4.000 mm**  
Packing **20 pz / box**  
Colour **B E**

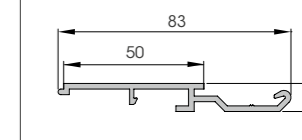

#### BUMT 150

To install with TM5

Packing **50 pz / box**  
Colour **B E**

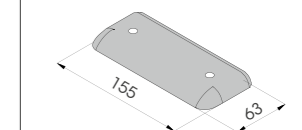

#### BUMT 250

To install with TS7

Packing **25 pz / box**  
Colour **E**

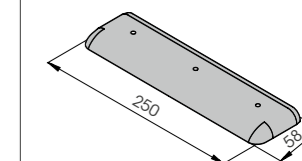

# 24

## WALL PROTECTION

New bumper without guides. Thanks to its big size and resistance it is ideal for protection of industrial spaces. Fixed caps with hidden screws covered by specific buttons.

Nuovo profilo antiurto senza guida. La sua ampiezza e resistenza lo rende ideale per la protezione di ambienti industriali. Terminali fissati con viti nascoste da appositi bottoni.

Nouveau profilé anti-choc sans besoin d'une base à fixer. Sa mesure large et sa résistance en font le profilé parfait pour la protection des espaces industriels. Embouts fixés avec des vis cachées grâce à des bouchons spécifiques.



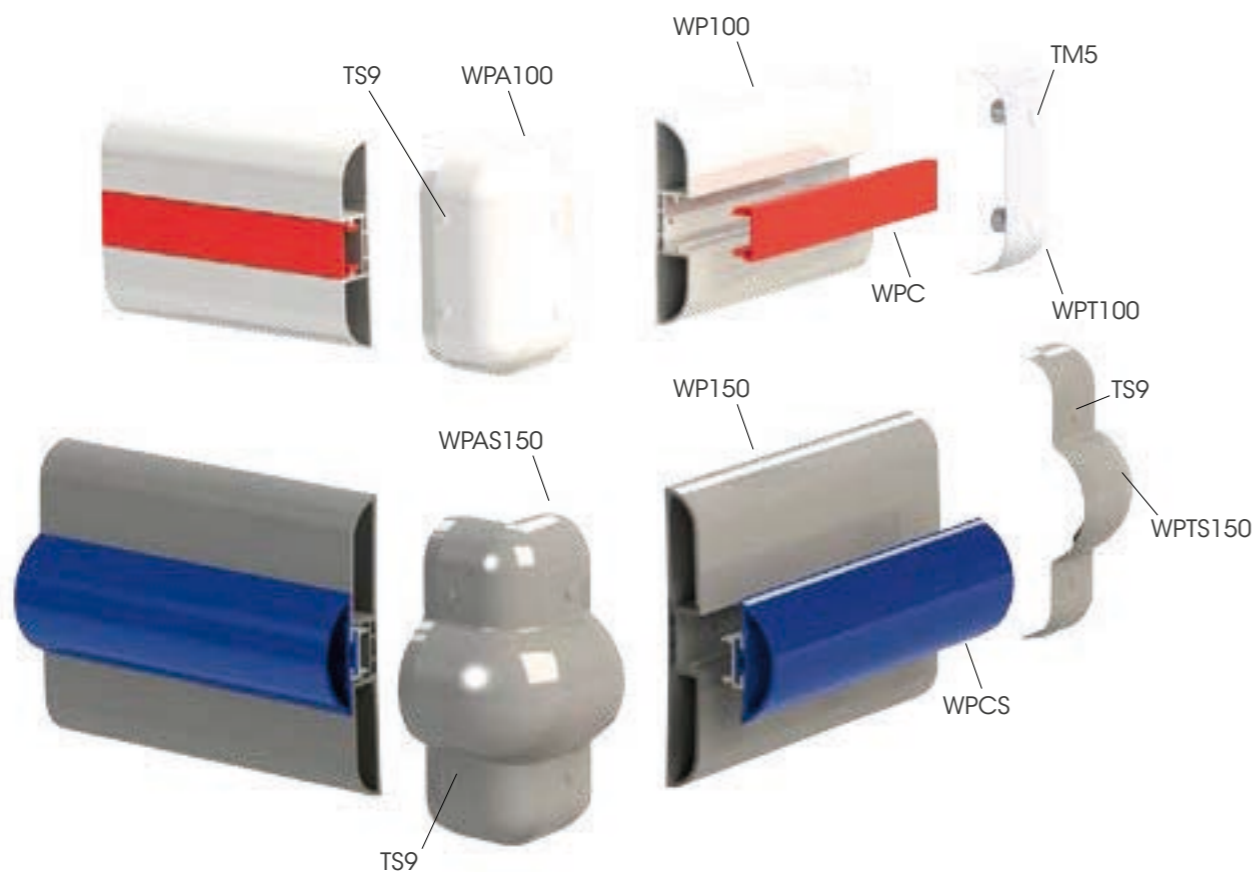

**WP 100**

Length **4.000 mm**  
Packing **8 pz / box**  
Colour **B E F**

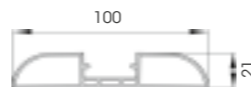

**WP 150**

Length **4.000 mm**  
Packing **4 pz / box**  
Colour **B C E**

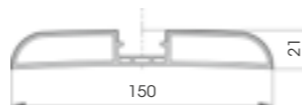

**WPC**

To install with WP 100 / WP 150

Length **4.000 mm**  
Packing **16 pz / box**  
Colour **A B C D E F G H**

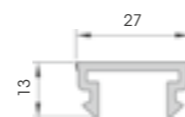

**WPT 100**

To install with TM5

Packing **50 pz / box**  
Colour **B E F**

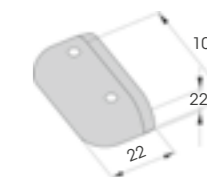

**WPA 100**

To install with TS9

Packing **20 pz / box**  
Colour **B E**

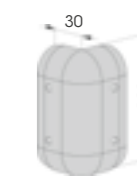

**WPT 150**

To install with TM5

Packing **50 pz / box**  
Colour **B E**

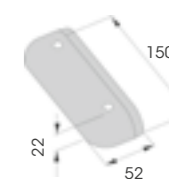

**WPA 150**

To install with TS9

Packing **20 pz / box**  
Colour **B E**



**WPCS**

To install with WP 100 / WP 150

Length **4.000 mm**  
Packing **8 pz / box**  
Colour **A B C D E F G H I J**

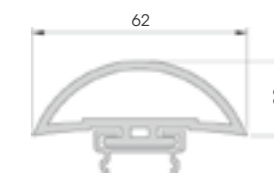

**WPTS 100**

To install with TS9

Packing **20 pz / box**  
Colour **B E**

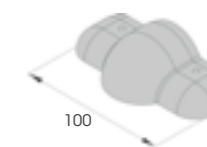

**WPAS 100**

To install with TS9

Packing **20 pz / box**  
Colour **B E**

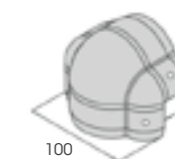

**WPTS 150**

To install with TS9

Packing **20 pz / box**  
Colour **B E**

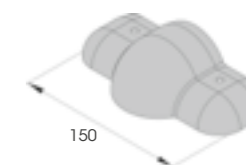

**WPAS 150**

To install with TS9

Packing **20 pz / box**  
Colour **B E**

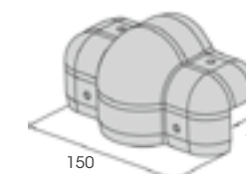

# 25

## BUMPER 150

Soft but strong material.  
Innovative and simple design.

Profilo antiurto in materiale morbido  
ma indistruttibile. Design semplice  
e versatile.

Profilé anti-choc réalisé avec un matériel  
souple et rigide indestructible.  
Design simple et innovant.



### Bumper 150

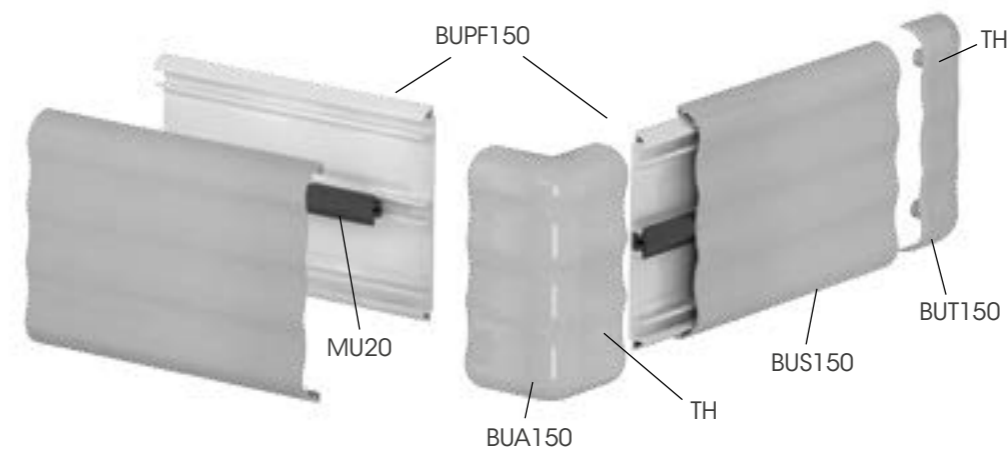

**BU 150**

Packing **1 pz / box**  
**L = 25.000 mm**  
Colour **I J L**

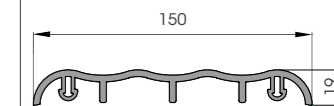

**BUS 150**

Length **4.000 mm**  
Packing **6 pz / box**  
Colour **B**



**MU 20**

Packing **1 pz / box**  
**L = 48.000 mm**

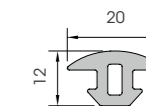

**BUPF 150**

Length **4.000 mm**  
Packing **6 pz / bag**

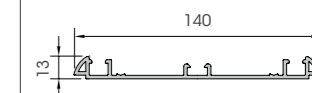

**BUT 150**

To install with TH

Packing **50 pz / box**  
Colour **B I J L**

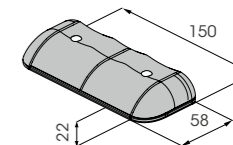

**BUA 150**

To install with TH

Packing **20 pz / box**  
Colour **B I J L**



# 26

## BUMPER FLOOR

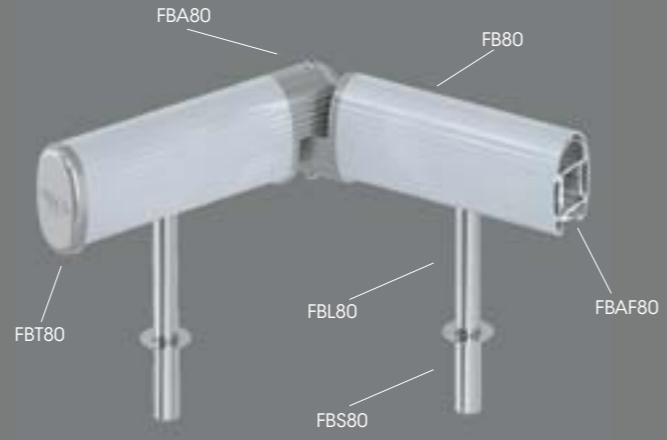

Spacer floor bumper to protect refrigerated cabinets and walls, fully equipped with corners and accessories necessary to assemble it.

Sistema di protezione distanziale a terra di banchi frigo e pareti, completo di curve e provvisto di accessori.

Système de protection au sol, épaisseur pour les vitrines réfrigérées et murs, pleine de courbes et équipé d'accessoires.



### Bumper Floor

	<b>FB 80</b> 	Length <b>4.000 mm</b> Packing <b>6 pz / box</b> Colour <b>B</b>	
	<b>FBAF 80</b>	Material <b>aluminium</b> Length <b>4.000 mm</b> Packing <b>6 pz / box</b>	
	<b>FBT 80</b> Equipped with screws	Material <b>aluminium</b> Packing <b>40 pz / box</b>	
	<b>FBA 80</b> Equipped with screws	Material <b>aluminium</b> Packing <b>8 pz / box</b>	
	<b>FBL 80</b> Equipped with screws	Material <b>steel</b> Packing <b>20 pz / box</b>	
	<b>FBS 80</b>	Material <b>steel</b> Packing <b>20 pz / box</b>	
	<b>FR</b>	Material <b>glue</b> Packing <b>1 pz / box</b>	
	<b>FBR</b>	Material <b>iron</b> Length <b>400 mm</b> Packing <b>to be defined</b>	



# 27 WHEEL SYSTEM

Complete system for sliding glass doors of refrigerated displays. Shockproof pvc profiles equipped with accessories to ensure a good insulation and consequently a considerable energy saving. A lower rail is installed to allow the easy sliding opening and closing of doors.

Sistema completo per le porte scorrevoli a vetro degli armadi a muro. Profili realizzati in pvc antiurto completi di accessori che assicurano un buon isolamento e di conseguenza un notevole risparmio energetico. Dotato di sistema di scorrimento che rende agevole l'apertura e la chiusura delle porte.

Système complet pour les portes coulissantes en vitre de vitrines réfrigérées. Profilés en pvc antichoc équipés d'accessoires pour assurer une bonne isolation et donc une économie d'énergie considérable. A rail inférieur est installé pour permettre le coulissement pratique de l'ouverture et de la fermeture des portes.

Wheel System





**SDF 20**

Length **4.000 mm**  
Packing **5 pz / box**  
Colour **B D**

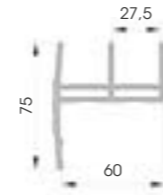

**SDW 20**

Length **4.000 mm**  
Packing **20 pz / box**  
Colour **B D**



**SDH 20**

Length **4.000 mm**  
Packing **12 pz / box**  
Colour **B D**

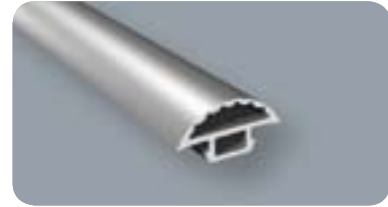
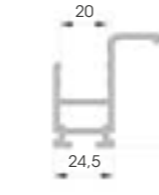

**SDHG**

Packing **60 mt reel**  
Colour **B D**



**RAIL**

Material **aluminium**  
Length **3.000 mm**  
Packing **to be defined**



**WHEEL**

Material **steel**  
Packing **100 pz / box**

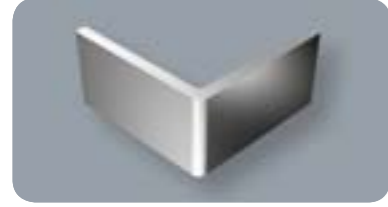
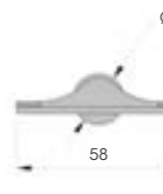

**SQ SDF**

To install with SDF

Material **aluminium**  
Packing **100 pz / box**

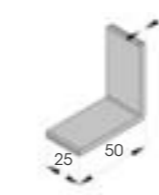

**SDW COP**

To install with SDW 20 and SDH 20

Packing **100 pz / box**  
Colour **B D**

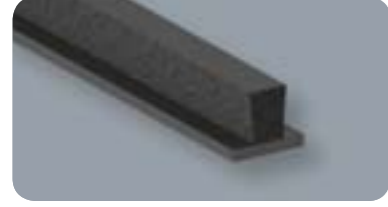

**BR 4**  
**BR 8.5**

Breaking resistance with 660 Kg. Self-tapping screw Ø 6,3 mm.

Length **BR 4**  
**BR 8,5**  
Packing **BR 4 1 pz / box L 600 mt**  
**BR 8,5 1 pz / box L 225 mt**  
Packing **D**

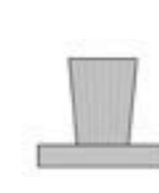

**FRIGOMONT<sup>®</sup>**  
**chladicí technika izolační panely**



# 28

## SLIDING SYSTEM

New profiles for covering refrigerated cabinets. With easy installation they can ensure hermetic closure and energy save.

Nuova linea di profili per la copertura di banchi frigo. Di facile installazione garantisce ermeticità e risparmio energetico.

Nouvelle gamme de profilés pour la couverture de meubles frigorifiques. Très facile à installer, elle garantit une fermeture hermétique et une économie d'énergie importantes.



### FLAT

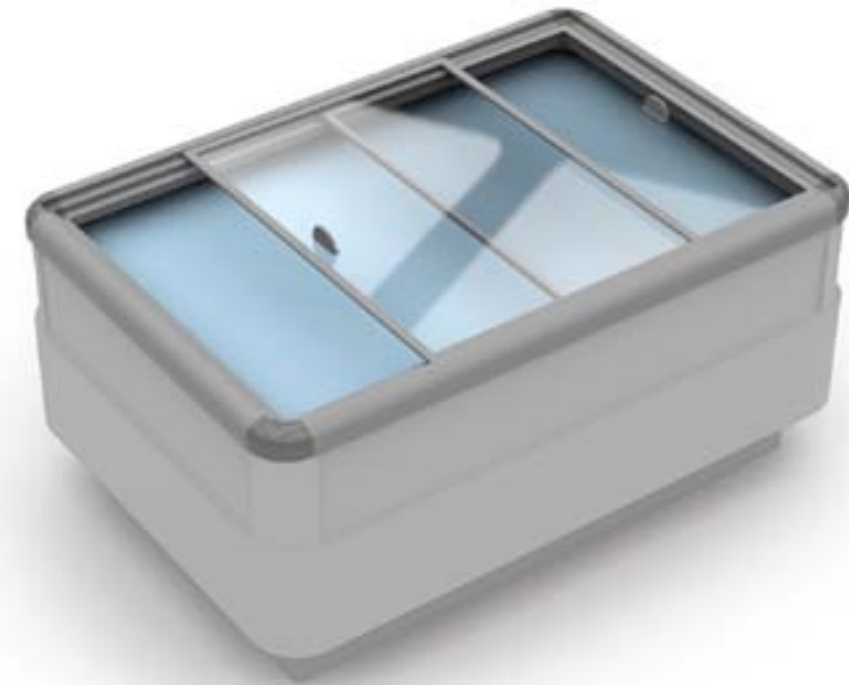

#### FLP

Length **4.000 mm**  
Packing **to be defined**  
Colour **B**

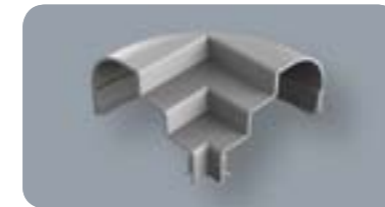
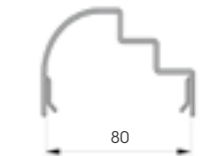

#### FLC

Length **4.000 mm**  
Packing **to be defined**  
Colour **B**

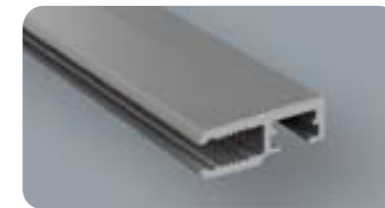
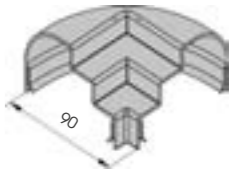

#### SSB

Length **4.000 mm**  
Packing **to be defined**  
Colour **B transparent**

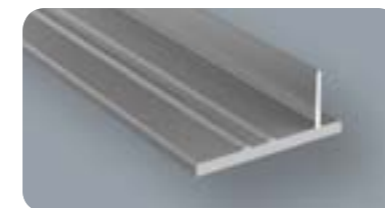

#### SSE

With double-sided tape

Length **4.000 mm**  
Packing **to be defined**  
Colour **B transparent**

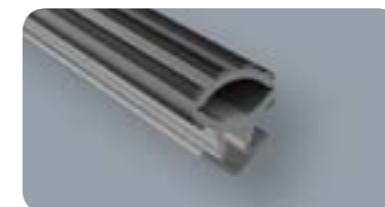

#### UG

Length **4.000 mm**  
Packing **to be defined**  
Colour **B transparent**



#### DG

Length **4.000 mm**  
Packing **to be defined**  
Colour **B transparent**

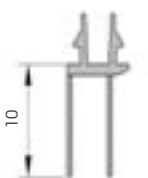

**CURVED**

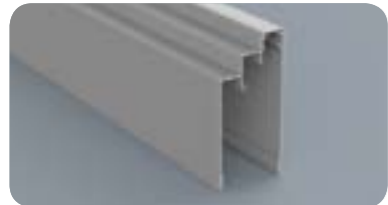
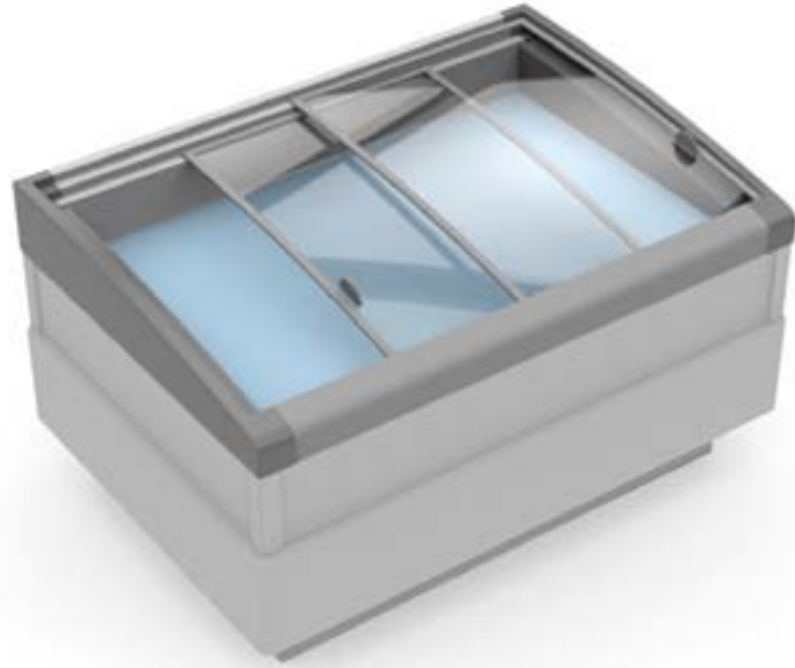

**CUB**

Length **4.000 mm**  
Packing **to be defined**  
Colour **B transparent**

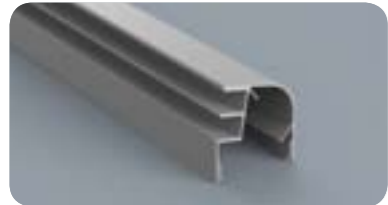

**CUF**

Length **4.000 mm**  
Packing **to be defined**  
Colour **B transparent**



**CUS SX / DX**

Packing **to be defined**  
Colour **B transparent**



**CUH**

Packing **to be defined**  
Colour **B transparent**



**SSB**

Length **4.000 mm**  
Packing **to be defined**  
Colour **B transparent**



**SSE**

With double-sided tape

Length **4.000 mm**  
Packing **to be defined**  
Colour **B transparent**

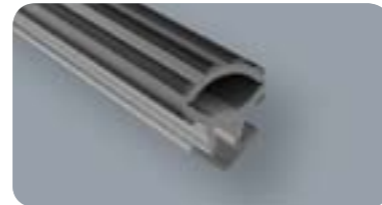
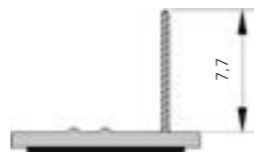

**UG**

Length **4.000 mm**  
Packing **to be defined**  
Colour **B transparent**



**DG**

Length **4.000 mm**  
Packing **to be defined**  
Colour **B transparent**

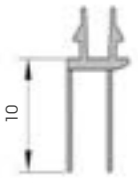

**RAIL**

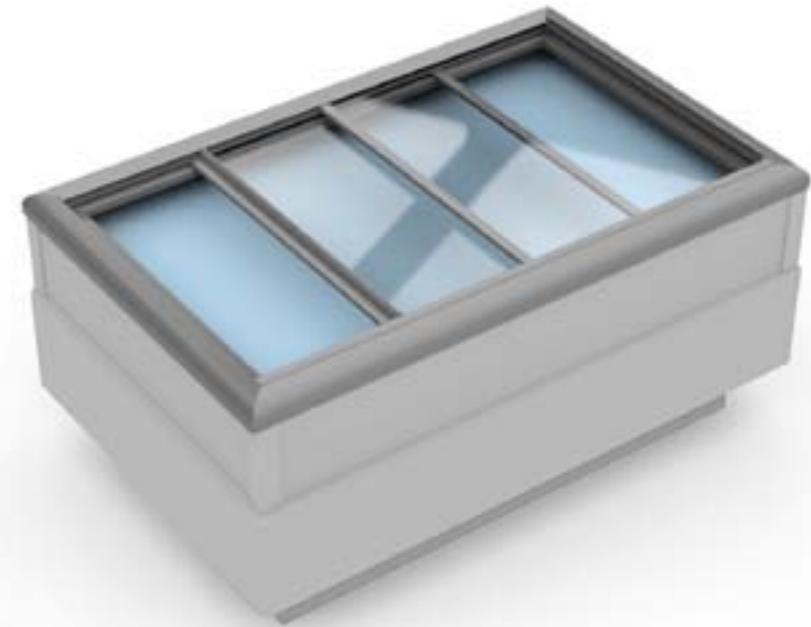

**RAP**

Length **4.000 mm**  
Packing **to be defined**  
Colour **K**

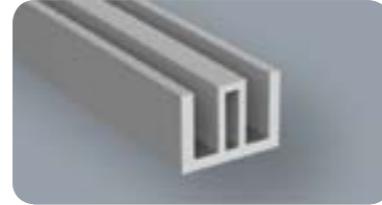
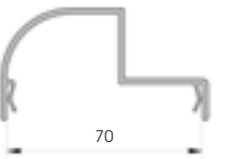

**RAEP**

Length **4.000 mm**  
Packing **to be defined**  
Colour **K**

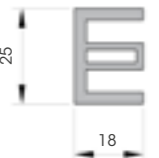

**HGF**

Length **4.000 mm**  
Packing **35 pz / box**  
Colour **K**

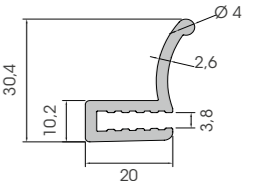

**GF**

Length **4.000 mm**  
Packing **35 pz / box**  
Colour **K**

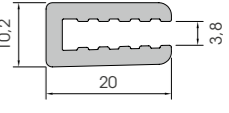

# 29 PVC PROFILES

## Angolo sanitario COVING AND CORNER PROFILES

Sono dotati di un supporto in resina termoplastica o in alluminio per consentire eventuali fissaggi strutturali fra pareti, soffitti e pavimenti. Alcuni particolari stampati consentono un rapido assemblaggio ed una efficace finitura degli angoli interni sia a due che a tre vie. Con la sigillatura longitudinale nell'apposita scanalatura si raggiungono altissimi livelli di igiene.

*Supported by a thermoplastic resin profile, may be supplied with an aluminium one to permit structural floor to walls and ceiling joints. Some items are provided with plastic details to ensure a quick and effective finishing of the internal corners both at two or three ways. Excellent hygienic performances may be also obtained by longitudinal sealing into the provided groove.*

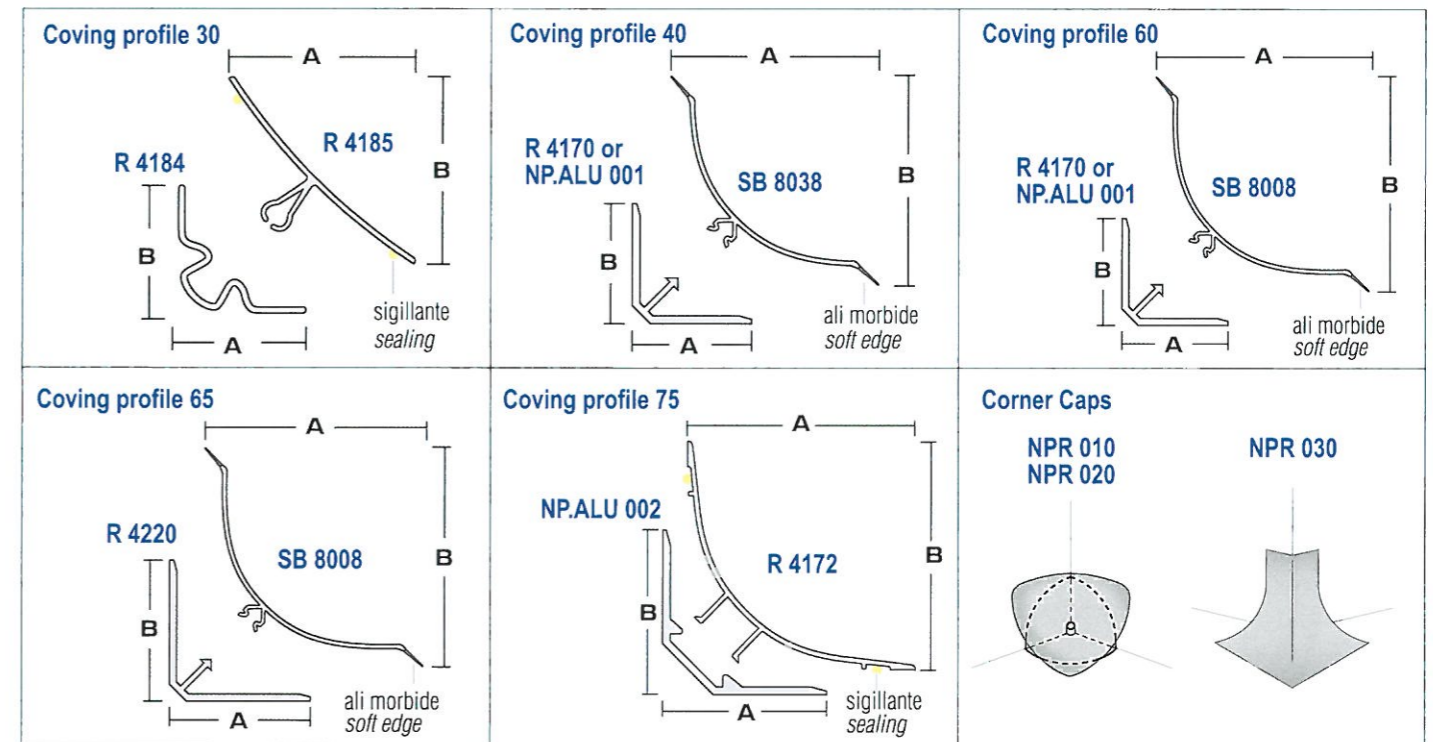
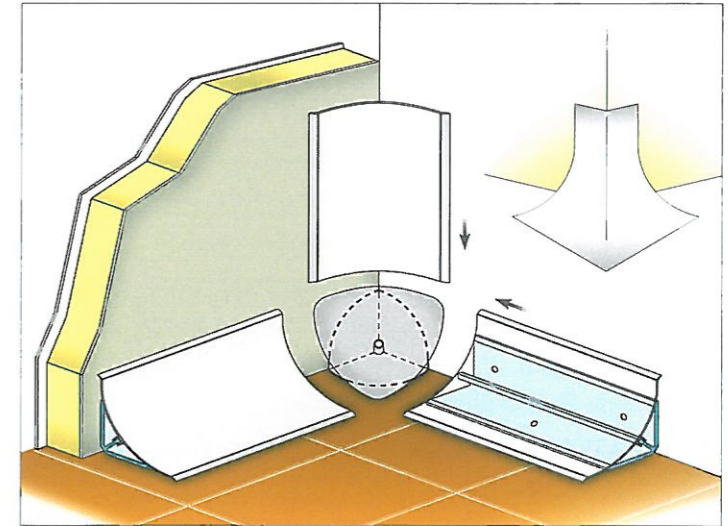

Art. n° Item n°	A mm	B mm	Lunghezza mm Length mm	Confezioni Packaging	Material Materials	Colori Colors
R 4170	30	30	4000	25 pz - pcs	PVC	Standard RAL 9010 RAL 9002
R 4172	75	75	4000	125 pz - pcs	PVC	
R 4184	30	30	4000	250 pz - pcs	PVC	
R 4185	42	42	4000	250 pz - pcs	PVC	
R 4220	40	40	4000	25 pz - pcs	PVC	
SB 8008	60	60	4000	25 pz - pcs	PVC	
SB 8038	40	40	4000	50 pz - pcs	PVC	
NP.ALU 001	30	30	4000	25 pz - pcs	ALU	
NP.ALU 002	50	50	4000	125 pz - pcs	ALU	
NPR 010	Raccordo angolo - Corner Cap (SB8008)			25/50 pz - pcs	PVC	
NPR 020	Raccordo angolo - Corner Cap (SB8038)			25 pz - pcs	PVC	
NPR 030	Raccordo angolo esterno - External Corner Cap (SB8008)			25 pz - pcs	PVC	



# Profilo battiscopa sanitario

## ROUNDED PLINTH PROFILE

Indispensabile dove sia richiesta, oltre alla tradizionale funzione di battiscopa, una facile sanificazione ambientale e la garanzia delle norme igienico sanitarie vigenti.

La messa in opera è veloce e definitiva, grazie all'unicità del profilo che non presenta elementi di fissaggio a vista. Il sistema è dotato di accessori che completano la posa del profilo nelle diverse tipologie (angoli interni, esterni, supporti e terminali).

*Our sanitary profile has a double function: besides the traditional one of plinth profile it is particularly useful to meet the current hygienic standards. The installation is quick and definitive thanks to the uniqueness of the profile: its peculiarity is to hide any fixing points. To complete the installation of the profile in all different situations our kit is provided with all necessary accessories (i.e. internal and external corners, mounting supports and terminals).*

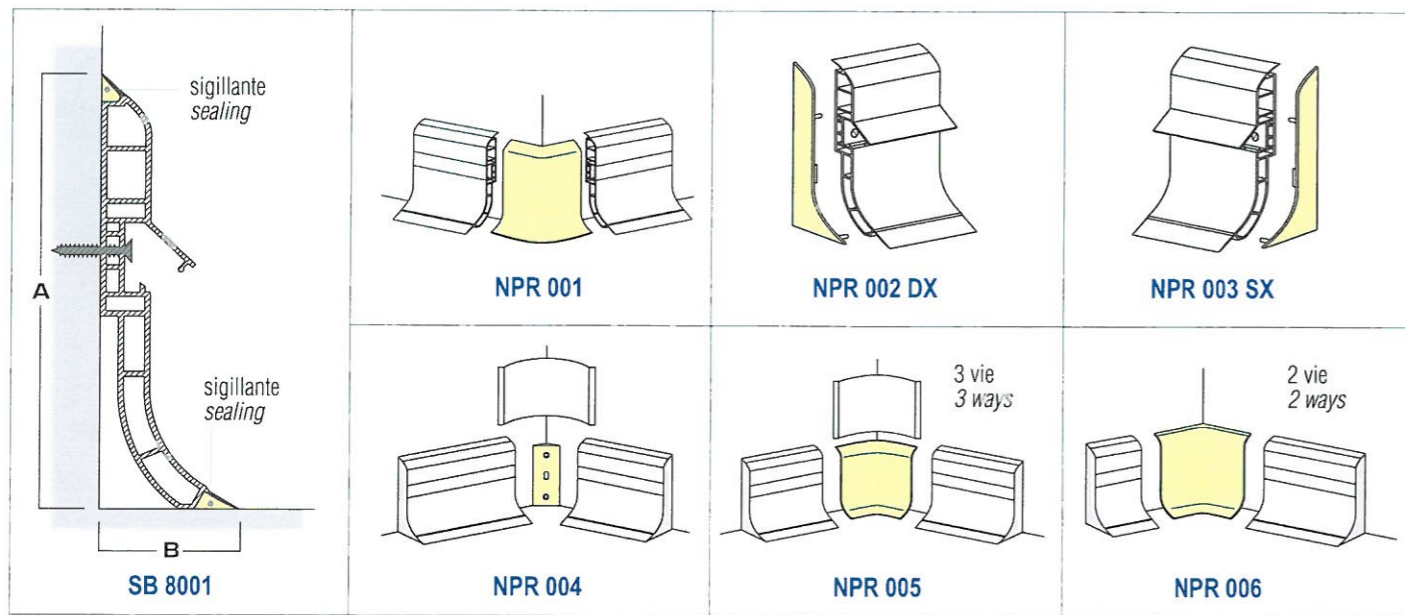
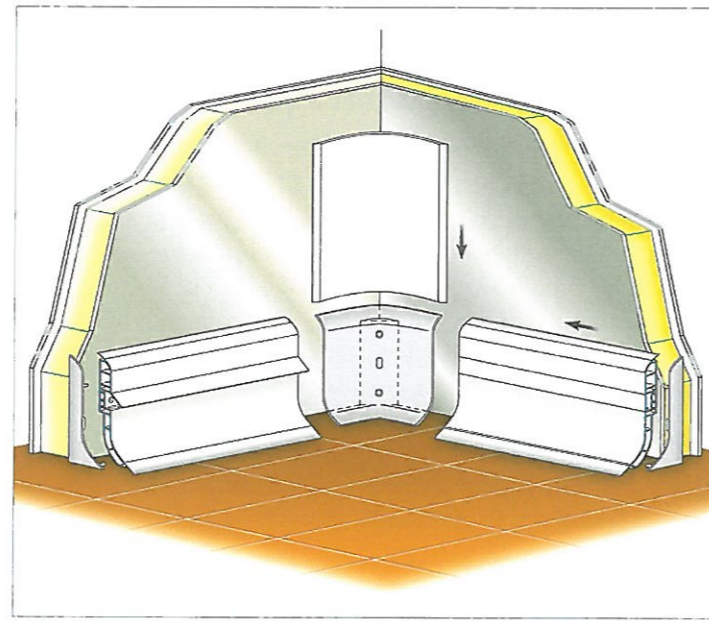

Art. n° Item n°	A mm	B mm	Lunghezza mm ngth mm	Confezioni Packaging	Colori Colors
SB 8001	90	30	4000	15 pz - pcs	Standard RAL 9010 RAL 9002
NPR 001	Raccordo angolo esterno - External corner cap			25 pz - pcs	
NPR 002 DX	Copertura destra - Right cover			50 pz - pcs	
NPR 003 SX	Copertura sinistra - Left cover			50 pz - pcs	
NPR 004	Supporto per NPRO5-06 - bracket for NPRO5-06			50 pz - pcs	
NPR 005	Raccordo angolo interno - Internal corner cap			25 pz - pcs	
NPR 006	Raccordo angolo interno - Internal corner cap			25 pz - pcs	

# Basi pavimento con e senza angolo sanitario "U" CHANNEL PROFILES

Si utilizzano nella prefabbricazione di ambienti ad atmosfera controllata direttamente collocati su pavimenti esistenti. Puramente strutturali, includono uno sguscio sanitario che ben risponde ai requisiti di igiene ambientale disposti dalle normative vigenti. La velocità di posa in opera, la foratura preordinata longitudinalmente al profilo, lo sguscio sanitario già strutturalmente inserito, l'unione d'angolo e il rinvio verticale conferiscono al prodotto assemblato tenuta ed economicità unici per il suo genere.

*Are useful and necessary for ready-made controlled temperature rooms directly based on pre-existing floors. They are merely structural and they may have a sanitary covering which perfectly meets the hygienic standards. Quick installation, prearranged longitudinal holes, ready coving, corner connection and vertical joint grant to the assembled product excellent sealing and good value for money.*

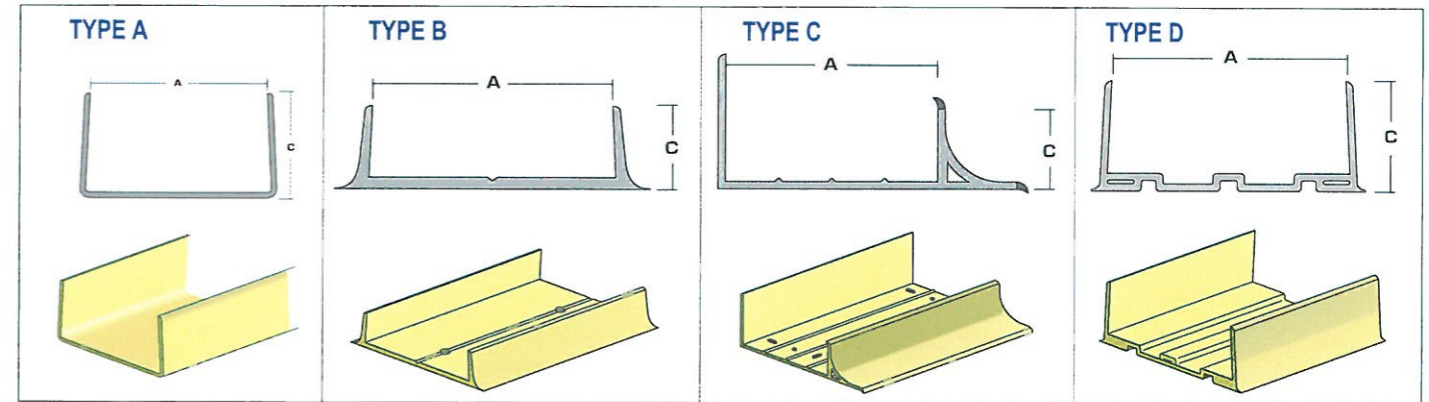
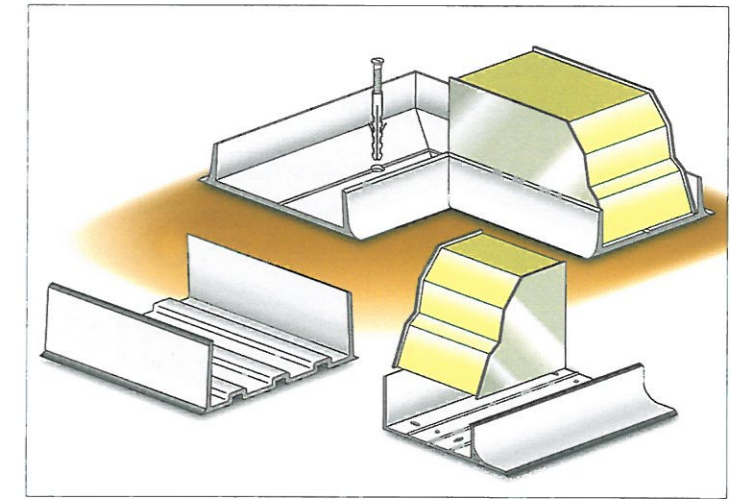

	Art. n° Item n°	A mm	C mm	Lunghezza mm Length mm	Colori Colors
TYPE A	R 4171	60	30	4000	Standard RAL 9010 RAL 9002
	R 4124	70	40	4000	
	R 4125	80	40	4000	
	R 4126	100	40	4000	
	R 4127	110	40	4000	
R 4128	120	40	4000		
TYPE B	R 4011	61	30	4000	
	R 4012	81	28	4000	
	R 4046	101	34	4000	
	R 4047	71	34	4000	
TYPE C	SB 8015	61	36	4000	
	SB 8016	101	36	4000	
	SB 8028	71	36	4000	
TYPE D	SB 8029	81	36	4000	
	R 4217	59	32	4000	
	R 4193	69	32	4000	
	R 4194	79	32	4000	
	R 4195	99	32	4000	

## Profili porta guarnizioni GROVE PROFILES FOR WEATHER STRIPS

Si adattano ai diversi stili di costruzione delle porte frigorifere per celle e contribuiscono ad evitare il ponte termico in modo da prevenire pericolosi punti di condensa. Su richiesta realizziamo guarnizioni con materiali a base di gomma sintetica resistenti sia alle basse che alle alte temperature (SB 920). A seconda della quantità, possono essere fornite in diverse colorazioni.

*Suitable for different cold room doors design, they give an important contribute to the thermic break to avoid dangerous condensing and frost formations. On request we develop gaskets made from synthetic rubber materials resisting to low and high temperatures (SB 920). They may be supplied in different colours depending on quantities.*

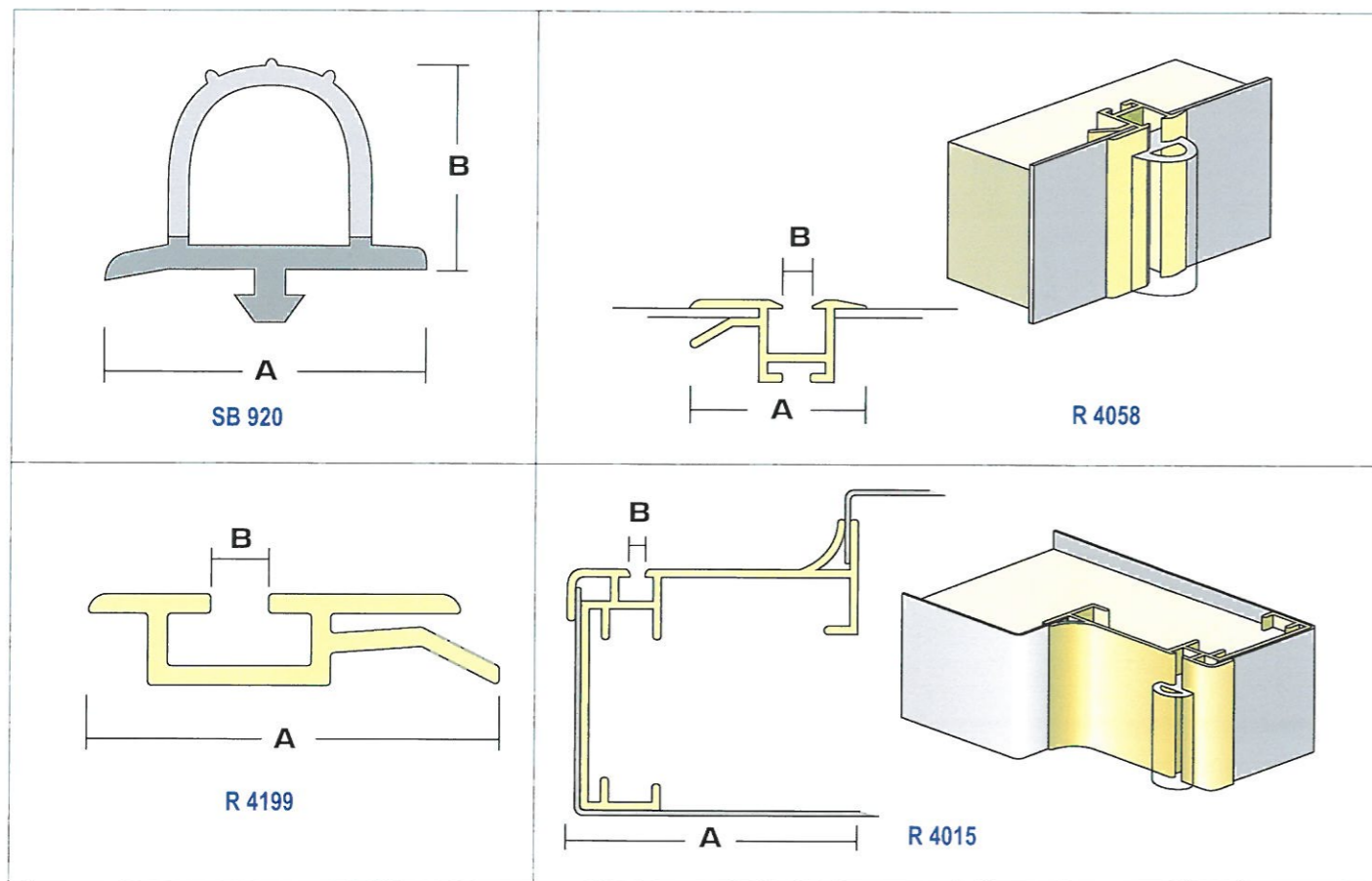
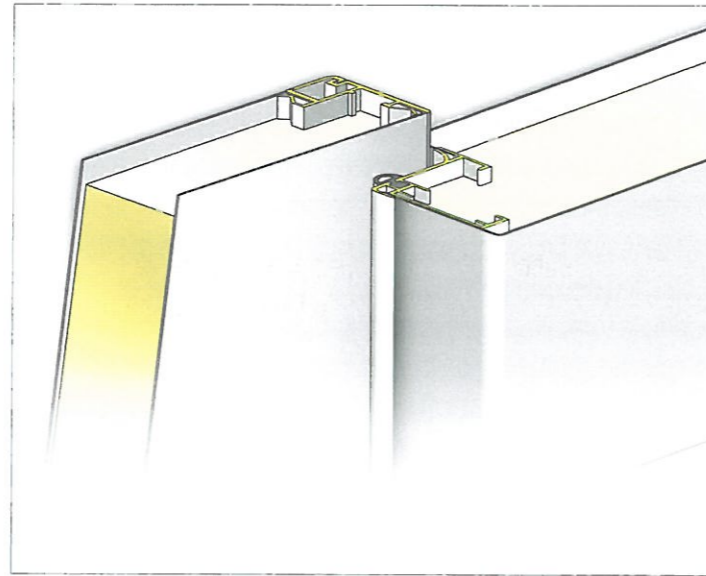

Art. n° Item n°	A mm	B mm	Lunghezza standard mm Standard length mm	Colori Colors
R 4015	57	3,5	4000	Standard RAL 9010 RAL 9002
R 4058	24	4	4000	
SB 920	28	20	-	
R 4199	31,5	4,4	4000	

## Profili porte e vani PROFILES FOR DOORS AND COUNTER FRAMES

Si utilizzano a completamento e finitura dei tradizionali pannelli coibenti nei vani porta per celle frigorifere. In ambienti refrigerati a basse temperature è ideale il profilo universale (R 4192) applicabile su pannelli di diverso spessore. Il pratico sportello d'ispezione permette di inserire e/o sostituire in un secondo tempo la resistenza elettrica necessaria al buon funzionamento delle aperture.

*Simple and inexpensive, they are used as completion and finishing of traditional insulating panels on door frames for cold rooms. In case of low temperature ambients we suggest our new universal profile (R 4192) which may be used on panels with different thickness. The practical inspection window allows to insert and/or replace the electrical resistance required for the correct door opening function.*

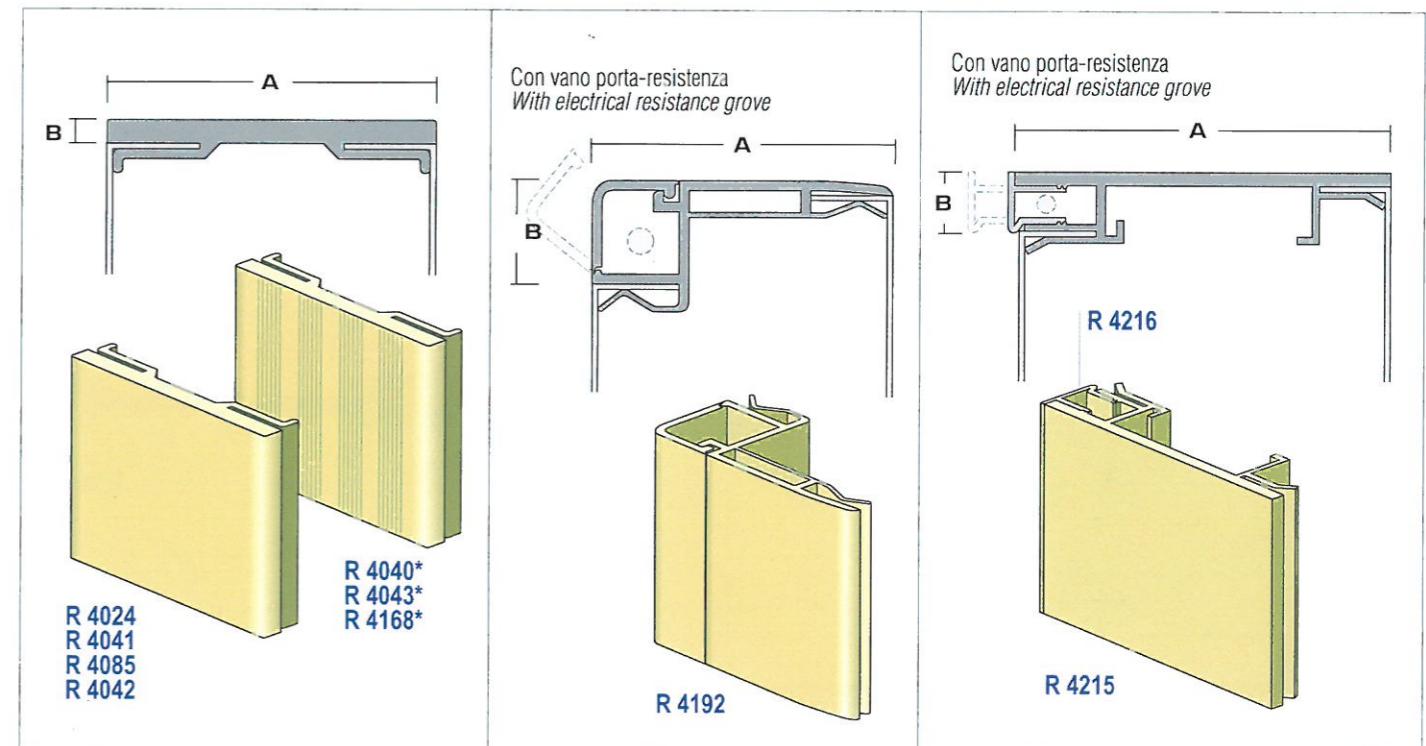
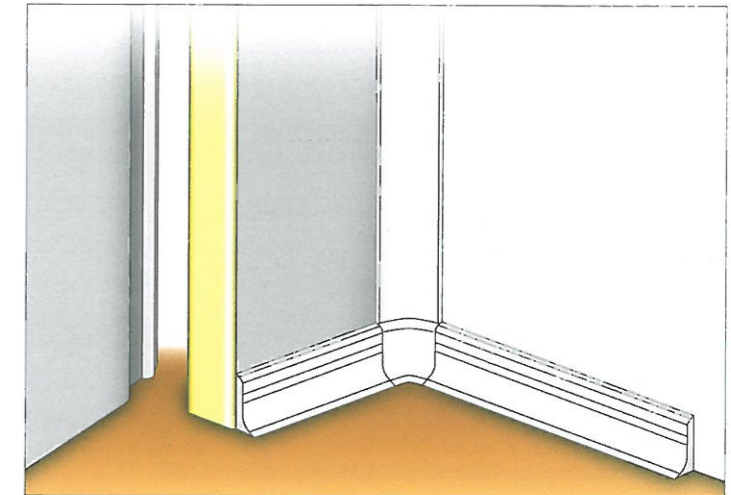

Art. n° Item n°	A mm	B mm	Lunghezza standard mm Standard length mm	Colori Colors
R 4024	30	-	4000	Standard RAL 9010 RAL 9002
R 4040*	90	3	4000	
R 4041	70	3	4000	
R 4042 - 43*	60	3	4000	
R 4168*	80	3	4000	
R 4085	100	3	4000	
R 4192	60	20	4000	
R 4215/R 4216	80	13	4000	

\*superficie microrigata - microruled surface

# Profili porte e vani

## PROFILES FOR DOORS AND COUNTER FRAMES

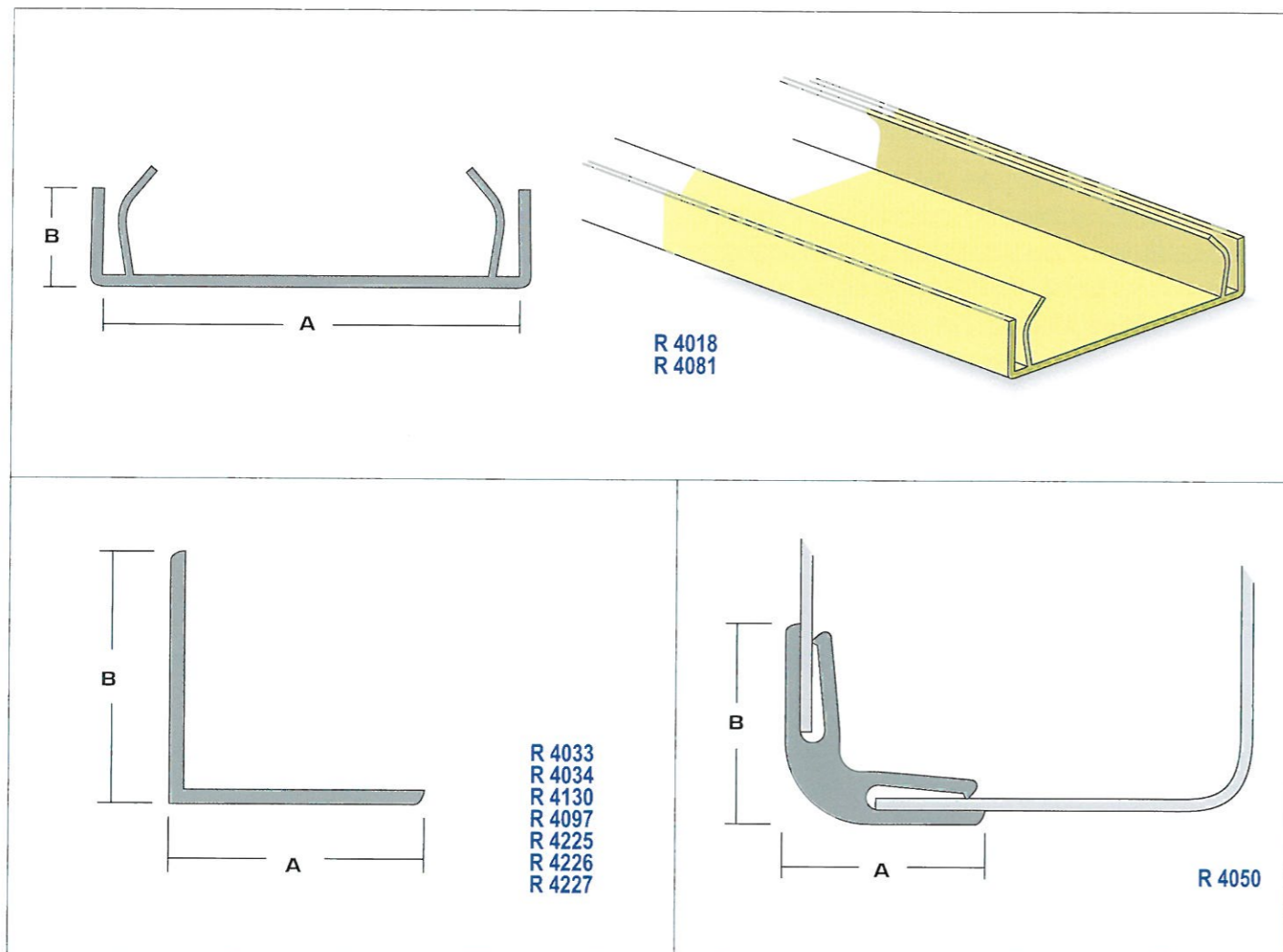

Art. n° Item n°	A mm	B mm	Lunghezza standard mm Standard length mm	Colori Colors
R 4018	30	12	4000	Standard RAL 9010 RAL 9002
R 4081	50	9	4000	
R 4033	20	20	4000	
R 4034	30	30	4000	
R 4130	60	60	4000	
R 4097	60	80	4000	
R 4225	60	120	4000	
R 4226	100	100	4000	
R 4227	140	140	4000	
R 4050	19	19	4000	

\*altezza variabile su richiesta - variable height on request

# Profili telaio per magazzini refrigerati

## FRAMES PROFILES

Permettono di ben definire gli spazi d'accesso delle grandi celle frigorifere. Sono elementi componibili per adattarsi a tutte le misure dei pannelli. Si possono fissare con particolari colle o meccanicamente. Il pratico sportello d'ispezione permette di inserire e/o sostituire in un secondo tempo la resistenza elettrica necessaria al buon funzionamento delle aperture.

*Our complete series of profiles for frame will give to you the right solution, due to complete the biggest cold rooms. Available in modular profiles permit to you a really support at the most business request. Easy to fix or install with special glue or mechanical fixation by steel or thermoplastic screw bolt. The practical inspection window allows to insert and/or replace the electrical resistance required for the correct door opening function.*

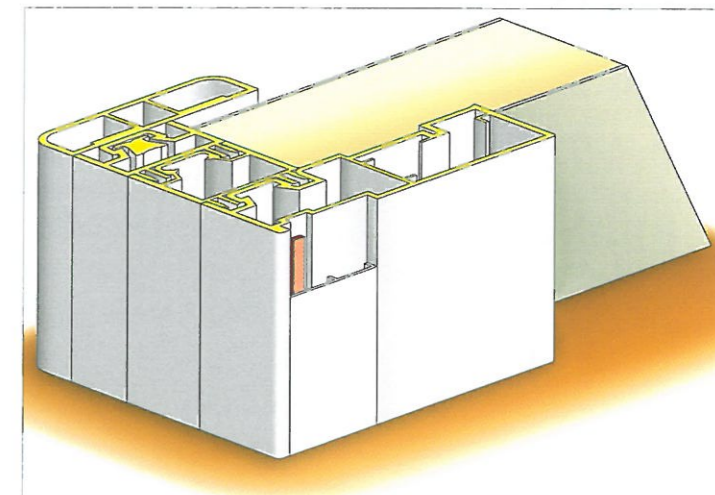

Sistema modulare  
Modular system

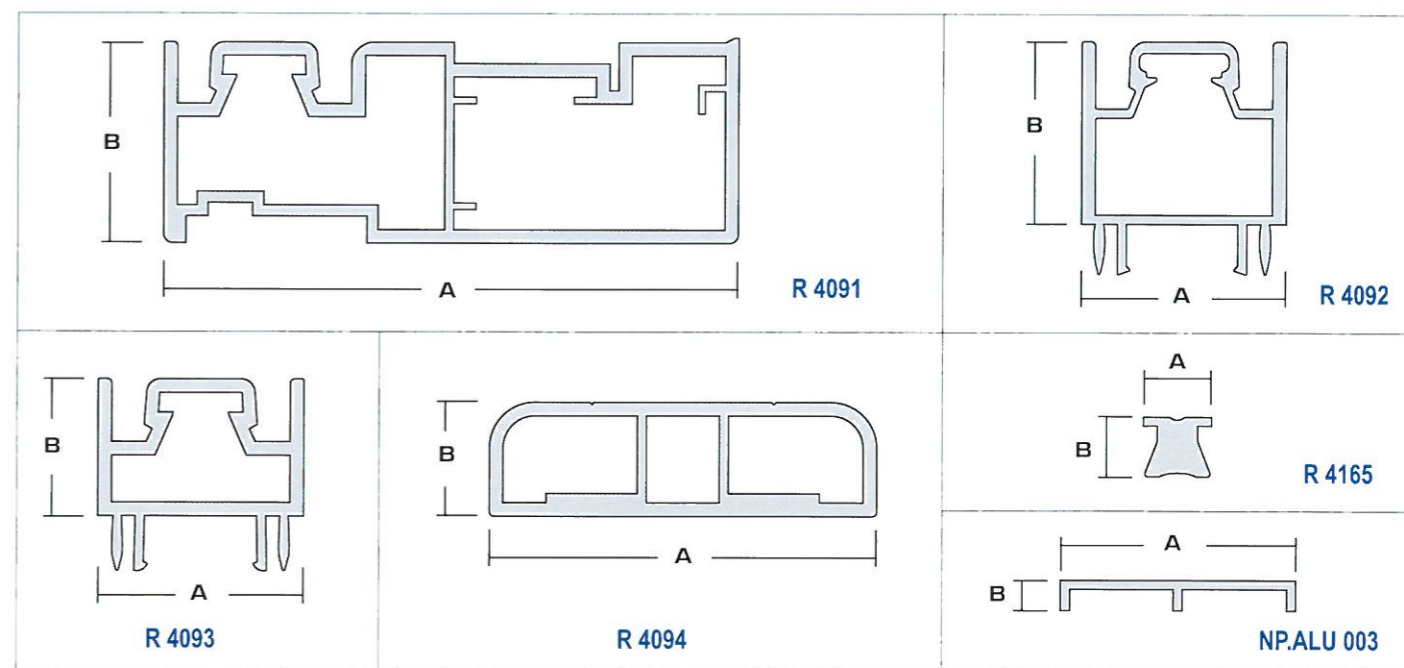
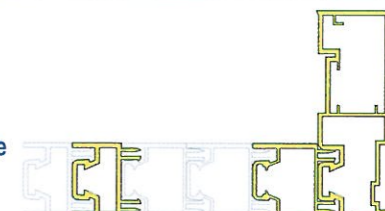

Le immagini qui proposte sono riproduzioni di profili estrusi che la New Plast ha realizzato nel corso degli anni per i propri clienti, in Italia e nel mondo, e sono proposte puramente a fini esemplificativi.

Art. n° Item n°	A mm	B mm	Lunghezza mm Length mm	Confezioni Packaging	Colori Colors
R 4091	129	45	6000	custom	Standard RAL 9010 RAL 9002
R 4092	45	40	6000	custom	
R 4093	45	30	6000	custom	
R 4094	85	25	6000	custom	
R 4165	14,8	13	6000	custom	
NP.ALU 003	38	5	6000	custom	





## Fixing accessories



**TH**  
ABS. 100 Pcs. / bag.  
RAL 9010 / 9002 / 9006 / 7040 / 7024 / Transparent.



**TB14**  
Hole required  $\varnothing 4$ .  
Steel, various colours. 500 Pcs. / box.



**TS5**  
Hole required  $\varnothing 5$ .  
White nylon. 250 Pcs. / bag.



**TB20**  
Steel, various colours. 500 Pcs. / box.



**TS7**  
Hole required  $\varnothing 5$ .  
White or grey nylon. 250 Pcs. / bag.



**TK100**  
Hole required  $\varnothing 5$  and  $\varnothing 20$ .  
Steel screw. Packing on demand.



**TM5**  
Neutral polyethylene. 100/500 Pcs. / bag.



**TS9**  
Hole required  $\varnothing 5$ .  
White or grey nylon. 250 Pcs. / bag.



**TM12**  
Hole required  $\varnothing 20$ .  
PE, RAL 9010. 100 Pcs. / bag.



**TK40**  
Steel screw.  
Packing on demand.

## Colours

<b>A</b>	<b>B</b>	<b>C</b>	<b>D</b>	<b>E</b>	<b>F</b>	<b>G</b>	<b>H</b>	<b>I</b>	<b>J</b>	<b>K</b>	<b>L</b>
RED RAL 3002	GREY RAL 7040	YELLOW RAL 1023	BLACK RAL 9005	WHITE RAL 9010	WHITE RAL 9002	BLUE RAL 5005	GREEN RAL 6029	SILVER RAL 9006	STEEL RAL 9023	7035 LIGHT GREY	7024 DARK GREY

Cleaner resistant	Good waterproof	<input checked="" type="checkbox"/> YES	<input type="checkbox"/> NO
Quick assembly	Easy to clean		
Shockproof	Good thermal insulation		
Cheap	Non toxic		
Long resistance	Class V0 self-extinguishing fire resistance		

All pictures are for illustrations purposes only. The company reserves the right to make changes in dimensions, colours, material and packaging without prior notice.



[www.frigomont.cz](http://www.frigomont.cz)

FRIGOMONT a.s., Borek 40, 380 01 Dačice, Czech Republic  
Tel.: (+420) 384 420 415 GSM: (+420) 724 022 030  
Fax: (+420) 384 420 042 GSM: (+420) 603 818 352  
E-mail: [frigomont@frigomont.cz](mailto:frigomont@frigomont.cz)  
IČ: 26032732, DIČ: CZ26032732

Bankovní kontakt: GE Money Bank a.s.  
Číslo účtu: 155333416/0600  
IBAN: CZ74 0600 0000 0001 5533 3416